

# PowerMaxPro



## User Guide

## Fully Supervised Wireless Alarm Control System



**Visonic**<sup>®</sup>

*For a secure way of life*

# POWERMAX PRO USER GUIDE

## Table of Contents

Compatibility of this Manual .....	2	<b>5. Reading Alarm Memory And Trouble Data</b>	<b>18</b>
Quick Guide To Primary Alarm Control Operations .....	2	Reviewing Alarm/Tamper Memory .....	18
Contact list form .....	2	Reviewing Trouble Information .....	18
Luminous Indicator Signals .....	2	Reviewing Memory & Troubles at the Same Time .....	19
Siren Signals .....	3	Correcting Trouble Situations .....	19
Useful Hints For PowerMax Pro Users .....	3	<b>6. Special Functions</b> .....	<b>20</b>
<b>1. Introduction</b> .....	<b>4</b>	Looking after People Left at Home .....	20
Overview .....	4	Emergency Calls for Help .....	20
System Features .....	5	Remote Control by Telephone .....	20
Terms of the Trade .....	6	Reporting to Private Telephone .....	22
Control Pushbuttons .....	6	Remote Control by SMS .....	22
Multi-Function Transmitter .....	7	Reporting by SMS .....	23
Proximity Tag .....	7	Reporting Messages to a Pager .....	23
Voice Announcements .....	7	Conducting a Walk-Test .....	24
Screen Saver Option .....	8	<b>7. User Settings</b> .....	<b>25</b>
<b>2. Securing the Protected Site</b> .....	<b>9</b>	What are the Settings You Need? .....	25
Security-Related Pushbuttons .....	9	Entering the User Settings Menu .....	25
Partition selection process .....	9	Bypassing Zones .....	26
Preparing to Arm .....	9	Reviewing the Bypassed Zone List .....	26
Arming 'AWAY' .....	9	Recalling the Last Bypass Scheme .....	27
Arming 'HOME' .....	9	Programming 4 Telephone Numbers .....	27
Switching from 'HOME' to 'AWAY' .....	9	Setting the User Codes .....	27
Switching from 'AWAY' to 'HOME' .....	10	Enrolling Keyfob Transmitters .....	28
Arming AWAY 'Instant' .....	10	Deleting Keyfob .....	28
Arming HOME 'Instant' .....	10	Enrolling Proximity Tags .....	28
Forced Arming AWAY .....	10	Deleting Proximity Tags .....	32
Forced Arming HOME .....	10	Setting the Voice Options .....	32
Arming in the Latchkey Mode .....	11	Automatic Arming Option .....	32
Initiating a Panic Alarm .....	11	Setting Arming Time .....	32
Initiating Fire Alarm .....	11	Enabling the Squawk Option .....	33
Initiating Emergency Alarm .....	11	Setting Time and Time Format .....	33
Disarming and Stopping Alarms .....	11	Setting the Date and Date Format .....	33
Siren Behavior .....	12	Scheduler Function .....	34
Proximity Tags .....	12	<b>8. Reading The Event Log</b> .....	<b>35</b>
Display when Partitioning is enabled .....	13	Event Log Description .....	35
<b>3. Speech And Sound Control</b> .....	<b>14</b>	Reading Procedure .....	35
Speech & Sound Cont. Push-buttons .....	14	<b>9. Maintenance</b> .....	<b>36</b>
Adjusting the Speech Volume .....	14	Replacing the Backup Battery .....	36
Voice ON/OFF .....	14	Replacing Wireless Sensors Batteries .....	36
Message Exchange .....	14	Periodic Testing .....	36
Message Playback .....	15	Cleaning the Control Panel .....	36
Chime ON/OFF .....	15	<b>10. Performance Limits</b> .....	<b>37</b>
<b>4. Electrical Appliance Control</b> .....	<b>16</b>	<b>APPENDIX A. GLOSSARY</b> .....	<b>38</b>
Control Options and Pushbuttons .....	16	<b>APPENDIX B. HOME FIRE ESCAPE PLANNING</b> .....	<b>39</b>
Manual Switch-On .....	16	<b>FCC STATEMENT</b> .....	<b>40</b>
Manual Switch-Off .....	16		
Light DIM/BRIGHT .....	16		
Automatic ON/OFF Control .....	16		

## Compatibility of this Manual

This manual should be used with PowerMax Pro v5.2.07 and above.

## Quick Guide To Primary Alarm Control Operations

QUICK REFERENCE TO PRIMARY ALARM CONTROL OPERATIONS		
Active Partition Selection (In Partition mode)	#	+  [PARTITION NO.]
Arming AWAY .....		+ [Code]*
Arming AWAY-INSTANT .....		+ [Code]* +
Arming HOME .....		+ [Code]*
Arming HOME-INSTANT .....		+ [Code]* +
Arming AWAY-LATCHKEY .....		+ [Code]* +
Force Arming AWAY (system not ready)		+ [Code]* +   (to silence the protest buzz)
Force Arming HOME (system not ready)		+ [Code]* +   (to silence the protest buzz)
Disarming and stopping alarms .....		+ [Code]

\* The factory default master user code is 1 1 1. The code is not required if quick arming has been permitted by the installer. Change the factory default code to a secret code without delay (see section 7)

## Contact list form

Dear Customer,

Thank you for choosing PowerMax Pro, a highly advanced wireless alarm control system produced by Visonic Ltd.

Please note below the installer's telephone number to facilitate obtaining assistance.

Company Name: \_\_\_\_\_

Telephone Number: \_\_\_\_\_

Person to Contact: \_\_\_\_\_

Also please make sure that you have the name and telephone number of the central station your system will report to. If you ever call the central station to ask questions, you should be able to come up with your "ACCOUNT NUMBER" used to identify your alarm system to the central station. Obtain this information from your installer and write it.

Monitoring Station's Name \_\_\_\_\_

Telephone Number: \_\_\_\_\_

My Account Number: \_\_\_\_\_

If you or your installer set the system to contact private telephone numbers, note down the 4 telephone numbers that your installer programmed to be called:

Phone No. 1: \_\_\_\_\_

Phone No. 2: \_\_\_\_\_

Phone No. 3: \_\_\_\_\_

Phone No. 4: \_\_\_\_\_

## Luminous Indicator Signals

Indicator	Behavior	Significance
(red)	Lights steadily	The system / a system partition(s) (*) is in the armed state (AWAY MODE)
	Flashes	The system / a system partition(s) (*) is in the armed state (HOME MODE)
	No light	The system is presently in the disarmed state <b>Note (*)</b> : Refers to the selected partition(s). If control panel is set to a single partition, an operation performed on other partitions will not be displayed.
(orange)	Lights steadily	The system / a system partition(s) (*) is presently in a state of trouble
	No light	No trouble - all is well <b>Note (*)</b> : Refers to the selected partition(s). If control panel is set to a single partition, an operation performed on other partitions will not be displayed.
(green)	Lights steadily	The chime function is active - chime zones will chime when disturbed.
	No light	The chime function is inactive - chime zones will not chime when disturbed.
(green)	Lights steadily	AC power is supplied to the control panel
	No light	The system is operating on backup battery power

\* Applicable to PowerMax Pro that includes PARTITION feature.

## Siren Signals

Alarm Type	Graphic Representation of Signal	Verbal Description of Signal
Burglar / 24 hour/ Panic	—————	ON continuously
Fire	--- --- --- --- .....	ON - ON - ON - pause - ON - ON - ON - pause.....
Test*	— (both external and internal sirens)	ON for 2 seconds (once)

\* Supplementary use only.

## Useful Hints For PowerMax Pro Users

**Stopping an alarm:** When the alarm sounds - press the DISARM (⏏) button on your key-ring transmitter or press  on the keypad and then enter your access code (1 1 1 1 by default).



**Stopping trouble beeps:** When trouble occurs in the system, the TROUBLE indicator on the front panel will light, and a sequence of 3 beeps will sound once per minute. If you do not wish to eliminate the trouble immediately and the beeps are bothersome, press the DISARM (⏏) button on your key-ring transmitter, or press  on the keypad and then enter your access code (1 1 1 1 by default). This will silence the buzzer for 4 hours, after which the trouble beeps will resume sounding. Be advised, however, that in any case the trouble beeps are silenced during night hours.

**Perimeter and interior zones versus 24-hour zones:** Most of the protection sensors in your system are linked to perimeter and interior zones. These zones **trigger** alarms while the system is in the **armed** state and **do not trigger** alarms while the system is in the **disarmed** state. Other sensors are linked to 24-hour zones which trigger alarms irrespective of arming/disarming.

**Arming while perimeter zones are not secured (doors and/or windows are open):** Your display will read "NOT READY" if a protected door or window is open. You can find out which zone is "not ready" by clicking the  button. You can eliminate the problem by closing the door/window or by performing "Forced arming" (zone deactivation) if this option was enabled by the system installer. In case you intentionally choose to bypass a zone, leave the door or window open and arm the system (a voice message will announce that "Forced Arming" is under way).

**Bypassed zones will not be protected during one arming period.**

**Gaining access to 24-hour zones:** If you wish to access a sensor defined as a 24-hour zone without causing an alarm:

- Click  - the display will read: **NORMAL MODE / WALK TEST.**
- Click  again - the display will read: **USER SETTINGS.**
- Click  - the display will read: **ENTER CODE \_\_\_\_.**

Key your secret 4-digit <User Code> - the buzzer will play the "happy Tune" (- - - ———).

You have 4 minutes during which the 24-hour sensor can be opened and accessed. When the 4 minutes are up, the system will automatically revert to the normal mode.

**Canceling accidental alarms:** Upon alarm, the internal sounder is activated first for a limited period of time (set by the installer). Then the external siren starts and the event is reported to the central monitoring station. If you accidentally cause an alarm, you may simply disarm the system before the external siren starts - the alarm will not be reported.

If you cause an alarm accidentally and the external siren has already started - you can still disarm the system within a time limit set by the installer (1 to 15 minutes, as desired). If you manage to disarm on time, a **CANCEL ALARM** message will be automatically sent to the central monitoring station.

**Failing to exit before the exit delay expires:** If you exit the protected site after the exit delay expires (the exit delay beeps stop), the system will interpret this as if you just entered. The entry delay countdown will begin and the entry delay beeps will sound. To prevent an alarm, you must disarm the system before the entry delay expires.

**Unauthorized entry took place while you were away:** If you hear alarm sirens when you are about to re-enter the premises, and lights which should be off are on - an intruder may still be inside or another event may have occurred. Do not confront the intruder - remain outside and call the emergency services.

# INTRODUCTION

## 1. Introduction

### Overview

The PowerMax Pro is a wireless alarm control system that provides protection against burglary, fire and tampering. In addition, it can be used to control lights and electrical appliances within your household and/or to monitor the activity of disabled or elderly people left at home. Status information is presented visually and verbally, and in most cases a recorded voice prompts you to take correct action.

The PowerMax Pro includes an optional partition feature. Partitioning allows you to have up to four independently controllable areas with different user codes assigned to each partition. A partition can be armed or disarmed regardless of the status of the other partitions within the system. For example, you can define the garage as partition 1, the basement as partition 2, the house as partition 3 and a safe as partition 4. Since each partition is independent of other partitions, you can arm or disarm each partition as desired without altering the states of the other partitions. Therefore, while arming or disarming your home this will not interfere with the safe that you desire to arm most of the time.

The PowerMax Pro is governed by a control panel (Figure 1) designed to collect data from various sensors that are strategically located within and along the perimeter of the protected site (Figure 2).

In the **disarmed state**, the system provides you with visual and verbal status information, and initiates an alarm if smoke is detected or upon disturbance in a 24-hour zone (a zone which is active 24-hours a day).

In the **armed state**, the system will initiate an alarm upon detection of disturbance in any one of the armed zones.

You will need a 4-digit security code to master the system (code 0000 is disallowed), and you can authorize 7 other persons to use the system by providing them with their own security codes.

Moreover, you can obtain up to 8 multi-function key-ring transmitters and proximity tags that will allow you and other users to easily control major functions.

Proximity tags enable authorized people to enter restricted areas. Presenting a valid proximity tag while the system is armed causes the system to disarm. Presenting a valid proximity tag while the system is disarmed causes the system to be armed in AWAY or HOME modes.

If the user has changed the state of the system from a high security mode to a lower security mode i.e. from ARM to DISARM, or from ARM to HOME, he will be prompted to enter the user code thus bypassing the QUICK ARM option.

The system identifies a wide range of events - alarms, attempts to tamper with sensors and several types of trouble. Events are automatically reported via PSTN or optional GSM to central monitoring stations (in digital form) and to private telephones (in plain language and/or SMS messages). The person receiving such a message is expected to investigate the event and act accordingly.

**IMPORTANT!** All you need to know to secure your premises can be found in Chapter 2 of this manual.

If you are not familiar with some of the terms used here, refer to Appendix A at the end of this guide.

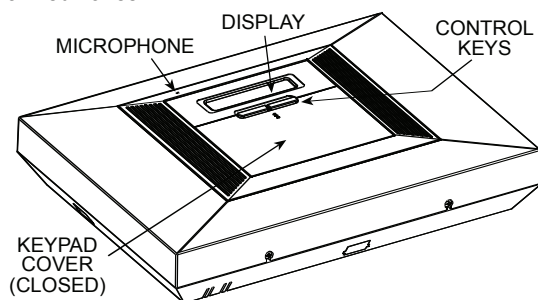

Figure 1. Control Panel with Cover Closed



# INTRODUCTION

**Note for PowerMax Pro with Partition feature:** Remote operation is performed per partition, or per user code defined for a particular partition.

- **Numerical keys serve as function keys:** In the disarmed state, numerical keys are used to control various system functions. A simple icon on each key identifies the task of that key.
- **Electrical device control:** Lights and electrical appliances can be controlled if optional X-10 modules are used. The electrical cabling network of the premises carries the control signals. Your installer will determine the control means in accordance with your needs.
- **PGM remote control:** Gate control mechanisms, courtesy lights and various other devices can be switched on and off via a special PGM (programmable) output. Your installer will determine the control means, in accordance with your needs. **Note for PowerMax Pro with Partition feature:** The X-10 and the PGM outputs operate on the entire alarm system and not per partition.
- **Data retrieval:** You can obtain status information, trouble information and review memorized alarm events - visually and verbally.
- **Looking after elderly, physically handicapped and infirm individuals:** The system can be programmed to monitor activity within the protected area and send out an alert message if the person under surveillance remains still for a predefined period of time (as set by your installer).
- **Distress calls:** Miniature pushbutton transmitters dealt out to specific individuals may be used for sending emergency calls for help.
- **Disarming under duress:** If a user is forcibly compelled to disarm the system, he can use a special code that disarms the system apparently as usual, but sends a silent alarm to the central station (see chapter 2).



- **System supervision:** All wireless peripherals within the protected site send periodic supervision messages. If such a message is overdue, the PowerMax Pro displays an 'inactivity' trouble message. Your installer can disable this feature if so desired.
- **Battery supervision:** You do not have to worry about 'dead' batteries. The PowerMax Pro displays a 'Low Battery' message whenever a battery in a wireless sensor is found to be near the end of its useful life.

## Terms of the Trade

Better understanding of your system is assured if you take time to read the definitions in **APPENDIX A** at the end of this manual. However, if this is not your first alarm system, then simply read on.

## Control Pushbuttons

When the keypad cover is closed, as shown in Figure 1, only two pushbuttons are visible - the top panel controls:

Key	Task
	Advance from item to item within a given menu.
	Review status messages one by one and also select a displayed option.

With the keypad uncovered (see Figure 3), the special-function keys are visible. The tasks of these keys are explained in the relevant sections of this guide.

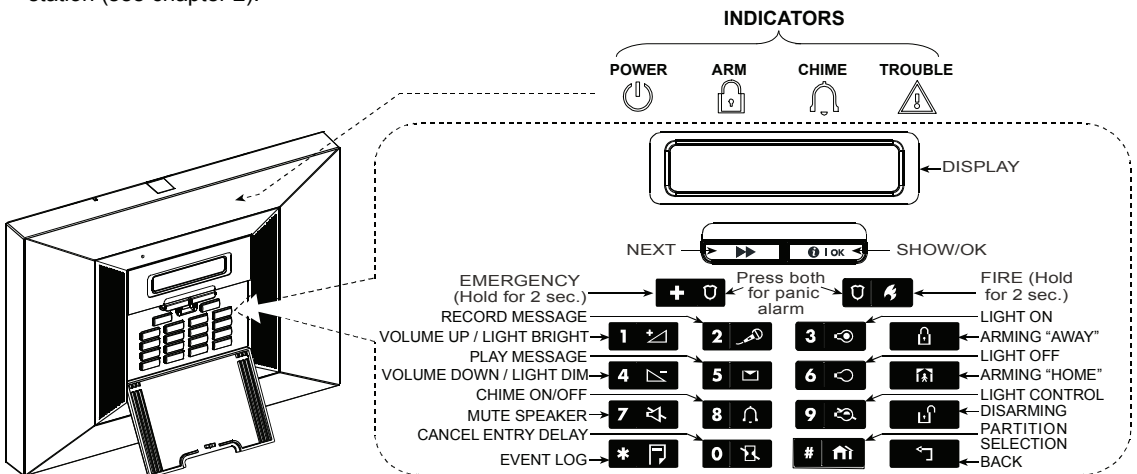

Figure 3. Controls and Indicators

## Note regarding the Mute Speaker button

The Mute Speaker button is active only if the "Set Voice Option" function is enabled ("enable prompts" - see user setting flow-chart, fig. 8).

## Multi-Function Transmitter

Your system responds to signals sent by a 4-button (MCT- 234) or a 6-button two-way (MCT- 237) 'keyfob' transmitter, or by a two-way wireless keypad (MKP-150/151) - see figure 4.

Both wireless keyfob transmitters are used to control the alarm system or a single predefined partition (\*). The two-way wireless keypad is used to control the entire alarm system but is not used when partition is enabled.

\* In PowerMax Pro with PARTITION feature.

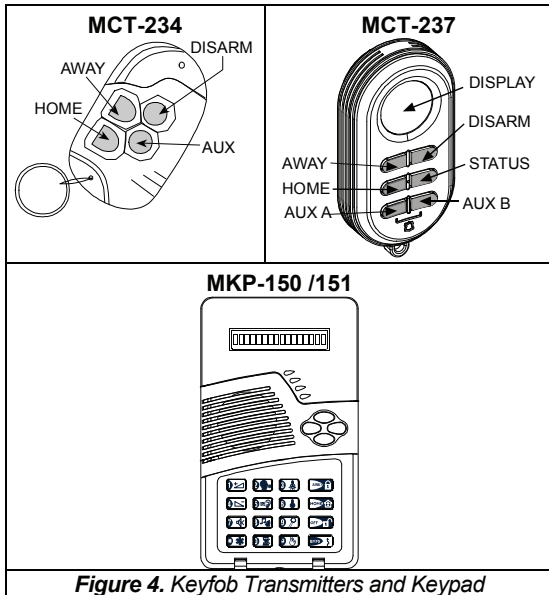

Figure 4. Keyfob Transmitters and Keypad

A PANIC alarm can be initiated: through the MCT-234 keyfob, by pressing AWAY and HOME together for 2 sec.; through the MCT-237 keyfob, by pressing the AUX1 and AUX2 buttons for 2 sec.; and through the MKP-150/151 keypad by pressing the # and \* buttons for 2 sec. Pressing AWAY twice within 2 seconds initiates Latchkey arming, if enabled by the installer. The devices can be used for:

- A. **Controlling a gate or another electrical device:** Pressing the AUX button opens/closes an electrically-controlled gate, or controls a chosen electrical d.
- B. **Arming the system in the INSTANT mode:** Pressing the AUX button immediately after arming, during exit delay, causes the system to be armed without an entry delay. This means that entering the protected premises via any zone will trigger an immediate alarm. You and

other holders of keyfob transmitters will have no problem, because you can disarm the system before entering by pressing the DISARM (DIS) button on your transmitter before entry.

- C. **Getting status information:** Upon pressing the aux button on your transmitter, the control panel announces the system status over the loudspeaker. In partition mode, the control panel announces the status of the partition to which the keyfob is enrolled.
- D. **Skip exit delay:** Pressing the AUX button will immediately cause the system to arm "instant".

## Disarming by a keyfob whose battery voltage is low (if enabled by the installer)

If you try to disarm the system with a keyfob whose battery voltage is low, a protest beep will be heard for 15 seconds. During this period you should press again the disarm button of the keyfob or control panel (for the control panel, user code is required) to disarm the system. If you perform this action during the 15 seconds period, the Low Bat acknowledge message will be stored in the event log.

If the disarm button is not pressed again during the 15 seconds period, perform either of the following actions when you want to rearm the system:

- A. Press AWAY twice to arm the system, otherwise the system will not be armed and an acknowledgement (from the user that he knows about the Low Bat) will not be stored in the event log.
- B. Press AWAY and then press disarm button, to acknowledge, otherwise the acknowledgement will not be stored in the event log.

## Proximity Tag

Your system responds to valid proximity tags enrolled to the system. The proximity tag enables you to perform a variety of functions without entering user code, for example, arming, disarming, reading the event log, etc. Whenever the user code is required, you can simply present a valid proximity tag and perform the desired operation without the need to key-in your user code.





## Voice Announcements

The pre-recorded voice announcements respond to your commands by announcing what the system is doing and by prompting you to perform certain actions. They also announce alarms, troubles and identify the source of each event.



# INTRODUCTION

The sounds you will hear while using the control panel are:

-  Single beep, heard whenever a key is pressed
-  Double beep, indicates automatic return to the normal operating mode (by timeout).
-  Three beeps, indicates a trouble event
-  **Happy Tune** (- - - —), indicates successful completion of an operation.
-  **Sad Tune** (———), indicates a wrong move or rejection

## Screen Saver Option

The purpose of the Screen Saver option (if enabled by the installer) is that when no key is pressed during more than 30 seconds, the display reads "PowerMax" and the LEDs do not light (to prevent an intruder to know the system status). The normal display returns after pressing the  button followed by entering user code (**Refresh by Code**) or after pressing any key (**Refresh by Key**), as selected by the installer.

If **Refresh by Key** was selected, the first pressing of any key (except Fire and Emergency) causes normal display return and the second press performs the key function. Regarding the Fire and Emergency keys, the first key press causes normal display return and also performs the Fire/Emergency function.

## 2. Securing the Protected Site

### Security-Related Pushbuttons

Key	Function
	Arming when nobody is at home
	Arming when people remain at home
	Canceling the entry delay upon arming ('AWAY-INSTANT' or 'HOME-INSTANT')
	Disarming the system and stopping alarms
	In Partition system used for Partition selection.
	In older versions of the PowerMax Pro used for testing.

### Partition selection process

**IMPORTANT NOTE:** Partitioning refers only to purchased control panels that support the partitioning feature.

Access to any desired partition is achieved through the use of an individual code or proximity tag. It is not possible to access the INSTALLER MENU if one or more partitions are in the AWAY or HOME modes.

Before attempting to perform any operation on any given partition(s), it is necessary to perform the operations below which enable you to select the desired/allowed partition(s) using the individual code or proximity tag:

**PRESS**



**RESULTANT DISPLAY**

SELECT PARTITION

Enter partition # (1 - 4)

PARTITION 1

**Note:** The "Sad Tune" will be heard when attempting to select a partition to which no sensors / peripherals were enrolled.

### Preparing to Arm

Before arming, make sure that READY (\*) / P# RDY (\*\*) is displayed. This means that all zones (\*) / partitions (\*\*) are secured and you may arm the system (\*) / partition (\*\*) any way you choose.

\* In non-partitioned system

\*\* In partitioned system

When **non partitioned system** is not ready for arming (at least one zone is open) the display is NOT READY TRBL (trouble), NOT READY MEM (memory), NOT READY MSG (message) or NOT READY BYPASS.

When **partitioned system** is not ready for arming (at least one partition zone is open), the display is N. RDY TRBL (trouble), N. RDY MEM (memory), N. RDY MSG (message) or N. RDY BYPASS.

If the system is not ready for arming, click to review the numbers and names of all open zones / partitions, one by one.

It is highly recommended to fix the open zone(s), thus restoring the system to the state of "ready to arm". If you do not know how to do this, consult your installer.

**IMPORTANT!** All arming procedures below are based on the assumption that quick arming has been enabled by the installer. If quick arming is disabled, the PowerMax Pro will prompt you to enter your security code before arming.

### Arming 'AWAY'

If the system is **READY**, proceed as shown:

**PRESS**



**RESULTANT DISPLAY**

ARMING AWAY

PLEASE EXIT NOW

↓ (Exit delay) ↓

Vacate the premises

AWAY

**ARM indicator** lights steadily during the armed state.

### Arming 'HOME'

If all perimeter zones are **READY**, and quick arming is allowed, proceed as shown:

**PRESS**



**RESULTANT DISPLAY**

ARMING HOME

Move to interior zone

↓ (Exit delay) ↓

AWAY HH:MM

**ARM indicator** flashes during the armed state.



### Switching from 'HOME' to 'AWAY'

Do not disarm the system - just press . The response will be the same as in ARMING AWAY above. Vacate the premises before the exit delay expires.

# SECURING THE PROTECTED SITE



## Switching from 'AWAY' to 'HOME'

Do not disarm the system - simply press . Since this operation reduces the security level, the PowerMax Pro will ask you to key in your master user code or user code, or present a valid proximity tag, thus making sure that you are an authorized user.

PRESS	RESULTANT DISPLAY
	ENTER CODE  _ _ _ _
[Enter code] Move to interior zone	ARMING HOME ↓ (Exit delay) ↓
	ARM HOME HH:MM

 **ARM indicator** flashes during the armed state.

If an alarm occurred while the system was armed in the AWAY mode, the display will respond differently:



PRESS	RESULTANT DISPLAY
	ENTER CODE  _ _ _ _
[Enter code] Move to interior zone	ARMING HOME ↓ (Exit delay) ↓
	HOME HH:MM ↶ (alternating) ↷
	ARM HOME MEMORY

 **ARM indicator** flashes during the armed state.

## Arming AWAY 'Instant'

You may arm AWAY or HOME without an entry delay - any detection in any zone will trigger an immediate alarm.



If you wish to arm AWAY-INSTANT, proceed as follows.

PRESS	RESULTANT DISPLAY
	ENTER CODE  _ _ _ _
	ARMING AWAY
	ARMING INSTANT ↶ (alternating) ↷
	PLEASE EXIT NOW ↓ (Exit delay) ↓
Vacate the premises	AWAY

 **ARM indicator** lights during the armed state.

## Arming HOME 'Instant'

If you wish to arm HOME-INSTANT, proceed as follows:

PRESS	RESULTANT DISPLAY
	ENTER CODE  _ _ _ _
	ARMING HOME
	ARMING HOME ↶ (alternating) ↷
Move to interior zone	ARM HOME INSTANT ↓ (Exit delay) ↓
	HOME HH:MM

 **ARM indicator** flashes during the armed state.



## Forced Arming AWAY

Forced arming allows you to arm any system partition even though one zone or several zones are disturbed, and the NOT READY message is displayed.

Automatic forced arming only works if the installer allowed this option while programming your system. Disturbed zones will be bypassed - they will not be armed. **The protected site will not have maximum protection.**

**Note:** When forced arming is carried out, the buzzer "protests" by emitting a continuous tone during the exit delay until the last 10 seconds of the delay. You can silence this signal by pressing the arming button again.

When NOT READY is displayed, Forced arming "AWAY" is performed as follows:

PRESS	RESULTANT DISPLAY
	ENTER CODE  _ _ _ _
	ARMING AWAY
	PLEASE EXIT NOW ↓ (Exit delay) ↓
(to mute the buzzer)	AWAY

 **ARM indicator** lights during the armed state.

## Forced Arming HOME

When NOT READY is displayed, Forced arming "HOME", is performed as follows:

# SECURING THE PROTECTED SITE

## PRESS



## RESULTANT DISPLAY

ENTER CODE █ █ █ █ █ █ █ █



ARMING HOME

↓ (Exit delay) ↓

(To mute the buzzer)  
Go to interior zone

HOME HH:MM

**ARM indicator** flashes during the armed state.

## Arming in the Latchkey Mode

This mode is useful for a parent at work who wants to be sure that his children have returned from school and have disarmed the system. Arming in the “latchkey” mode means that a special “latchkey” message will be sent out when the system is disarmed by a “latchkey user”.

Latchkey users are holders of user codes 5 through 8 or users of Keyfob transmitters 5 through 8. The latchkey message is considered an **alert** and not an alarm, and is therefore sent to the private telephones programmed by the user as targets for alert messages.

Latchkey arming is possible only when you arm “AWAY”. To arm in the Latchkey mode, proceed as follows with the appropriate Keyfob:

## PRESS



## RESULTANT DISPLAY

ARMING AWAY



ARMING LATCHKEY

(Within 2 seconds)

↶ (alternating) ↷

PLEASE EXIT NOW

Vacate the premises

↓ (Exit delay) ↓

AWAY

**Note:** Latchkey must be enabled by your installer.

**ARM indicator** lights during the armed state.

## Initiating a Panic Alarm

You can generate a panic alarm manually in the disarmed and armed states alike. The sequence will be as shown:

## PRESS



## RESULTANT DISPLAY

PANIC ALARM

READY HH:MM

**Note:** If you are using a key-ring transmitter, press both AWAY and HOME buttons (MCT-234) or AUX1 and AUX2 (MCT-237) simultaneously for 2 seconds.

To stop the alarm, press and then key in your valid user code.

## Initiating Fire Alarm

(This function is disabled in ACPO compliant version). You can generate a fire alarm in disarmed & armed states, as follows:

## PRESS



## RESULTANT DISPLAY

FIRE

Then, if or when the system is in the disarmed state:

READY HH:MM

↶ (alternating) ↷

READY MEMORY

To stop the alarm, press and then key in your valid user code.

## Initiating Emergency Alarm

You can generate an emergency alarm manually in the disarmed and armed states, as follows:

## PRESS



## RESULTANT DISPLAY

EMERGENCY

Then, if or when the system is in the disarmed state:

READY HH:MM

↶ (alternating) ↷

READY MEMORY

## Disarming and Stopping Alarms

(This function is disabled in ACPO compliant version). Disarming the system stops the siren before it stops automatically, irrespective of whether the alarm was initiated in the armed or the disarmed state.

After disarming, different displays may appear, depending on the current status of the system:

**A. Disarming - no events:** After an uneventful armed term the disarming operation will progress as shown:

## PRESS



## RESULTANT DISPLAY

CODE █ █ █ █ █ █ █ █

READY HH:MM

**ARM indicator** extinguishes

**B. Disarming after alarm, with all zones ready:** If the zone that alarmed in the armed state is back to normal the disarming operation will progress as shown:

# SECURING THE PROTECTED SITE

## PRESS      RESULTANT DISPLAY



CODE ███\_ \_ \_ \_

READY HH:MM

↶ (alternating) ↷

READY MEMORY

**ARM indicator** extinguishes.

To read the alarm memory, refer to Chapter 5. The "**MEMORY**" message will disappear only upon re-arming the system.

- C. Disarming after an alarm, with one zone still disturbed:** If the zone that alarmed in the armed state is still disturbed the disarming operation will progress as shown:

## PRESS      RESULTANT DISPLAY



CODE ███\_ \_ \_ \_

NOT READY HH:MM

↶ (alternating) ↷

NOT READY MEMORY

**ARM indicator** extinguishes

To read the alarm memory, refer to Chapter 5. The "**MEMORY**" message will disappear only when you rearm the system.

If you do not know how to return the disturbed zone to normal, consult your installer.

- D. Disarming with the system in a state of trouble:** If trouble is detected in the armed state, the **TROUBLE** indicator on the front panel will light and the disarming operation will progress as shown:

## PRESS      RESULTANT DISPLAY



CODE ███\_ \_ \_ \_

READY HH:MM

↶ (alternating) ↷

READY TROUBLE

**ARM indicator** extinguishes and sounds once per minute,

To find out what kind of trouble is being sensed, see Chapter 5. The **TRBL** display will disappear, the **TROUBLE** indicator will extinguish and the trouble beeps will stop upon eliminating the cause for trouble.

- E. Disarming after an alarm, with the system in a state of trouble:** The **TROUBLE** indicator on the front panel will light. If the zone that alarmed while the system was in the armed state reverts to normal mode the disarming operation will progress as shown:

## PRESS      RESULTANT DISPLAY



CODE ███\_ \_ \_ \_

READY HH:MM

↶ (alternating) ↷

READY TRBL

↶ (alternating) ↷

READY MEMORY

**ARM indicator** extinguishes and sounds once per minute.

To find out which zone alarmed and what kind of trouble is being sensed, see Chapter 5. The **TRBL** display will disappear, the **TROUBLE** indicator will extinguish and the trouble beeps will stop upon eliminating the cause for trouble. The **MEMORY** message will disappear only upon rearming the system.

- F. Disarming under Duress.** If you are forcibly compelled to disarm the system, enter the duress code (**2580** by default) or another code set by the installer. Disarming will take place normally but a silent alarm will be transmitted to the central station.

## Siren Behavior

The total siren time does not exceed the maximum time as configured by the installer.

**Continuously ON** when initiated by a burglar zone or a 24-hour zone, and when a user initiates a "panic alarm".

When initiated by a fire zone (smoke is detected) **ON - ON - ON - pause - ON - ON - ON - pause - .....** and so on.



If there is nobody around to disarm the system upon alarm, the siren will sound for the time duration set by the installer - then will stop. The strobe light will keep flashing until the system is disarmed.

## Proximity Tags

Valid proximity tags enable you to perform variety of functions without entering user code, for example, arming, disarming, reading the event log, etc. Whenever user code is required, you can simply present a valid proximity tag instead of entering user code.

# SECURING THE PROTECTED SITE

When the system is disarmed, after presenting a valid proximity tag to the control panel, the message "<OK> for AWAY" is displayed. Now you can press the  button to immediately arm the control panel, or wait for 3 second for system automatic AWAY arming (the message "Please exit now" will be displayed). Presenting the proximity tag once again will DISARM the system.

Instead of pressing the  button (see above), you can press the  button once / twice (the message "<OK> for HOME" / "<OK> for disarm" is displayed, accordingly) and then press the  button for HOME arming / disarming.

The control panel transmits an RF signal. A valid proximity tag that is presented to the control panel transmits a coded RF signal back to the control unit.

## Display when Partitioning is enabled

In Non-Partition mode	In Partition mode (for example partition #3)
READY	RDY
NOT READY	N.RDY
ARM AWAY	P3 ARM AWAY
PLEASE EXIT NOW	P3 PLS EXIT NOW
AWAY	P3 AWAY
ARM HOME	P3 ARM HOME
AWAY HH:MM	P3 AWAY HH:MM
HOME HH:MM	P3 HOME HH:MM
ARM HOME MEMORY	P3 HOME MEM
ARMING INSTANT	P3 ARM INSTANT
ARM HOME INSTANT	P3 ARM HOME INST
ARMING LATCHKEY	P3 ARM LATCHKEY
READY HH:MM	P3 RDY HH:MM
READY MEMORY	P3 RDY MEM
NOT READY HH:MM	P3 N.RDY HH:MM
NOT READY MEMORY	P3 N.RDY MEM
READY TRBL	P3 RDY TRBL

## 3. Speech And Sound Control

### Speech & Sound Cont. Push-buttons

The sound and speech-related functions offered by the PowerMax Pro are controlled using the built-in keypad, as detailed in the following list.

#### For PowerMax Pro that include partition feature:

Sound and speech-related features only apply to the partition(s) where the control panel is present. An activity performed via the control panel from another partition will be displayed and the LED will light. The operation will be added to the log file but will not be heard over the control panel speaker.

Key	Function
	Increasing the loudness of spoken messages
	Decreasing the loudness of spoken messages
	Enabling / disabling the loudspeaker
	Recording a spoken message for other users of the alarm system
	Listening to a recorded message left by another user of the alarm system
	Enabling / disabling the chime function in chime zones

### Adjusting the Speech Volume

The following diagram shows how to increase the loudness by clicking the <1> key (assuming that the volume was at minimum to begin with).

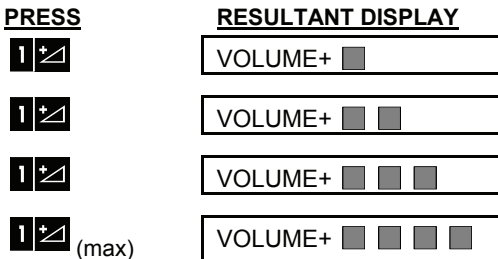

The following diagram shows how to decrease the loudness with the <4> key (assuming that the volume was at maximum to begin with).

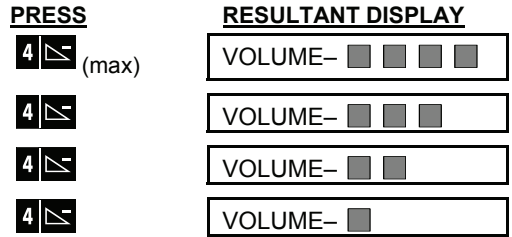

### Voice ON/OFF

You can switch spoken announcements on and off by alternate clicking of the <7> key, as shown below.

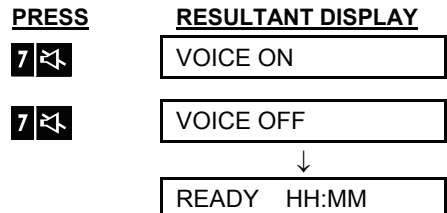

*Note: The system will maintain the "Voice OFF" state until subsequent selection of "Voice ON".*

### Message Exchange

For message exchange you can record a verbal message for other users of the alarm system. Face the panel, press <2> and keep it pressed. When the display reads **TALK NOW**, start talking. The 5 dark boxes will slowly disappear one by one, from right to left, as shown in the diagram below.

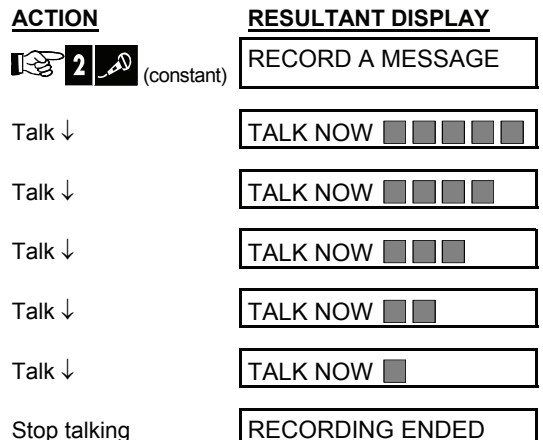

# SPEECH AND SOUND CONTROL

Once the last of the boxes disappears, **RECORDING ENDED** will be displayed.

When you release the button, the display will revert to the normal status-displaying mode, but will also indicate that a message is waiting. For example:

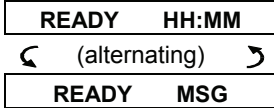

To check your own message, listen to it within one minute from the end of recording (see Chapter 3 - Message Playback). This way the **MSG** indication will not be erased.

**Note:** *The message recording feature refers to the entire system and not per partition.*

## Message Playback

To listen to a message left by another user of the system:

Click **5**  and listen. **PLAY** will be displayed and the message will be played back over the built-in loudspeaker. When the playback ends, the display will revert to the normal status-displaying mode. If more than 1 minute elapsed after recording, the **MSG** indication will disappear.

## Chime ON/OFF

You can disable / enable the chime zones by alternate clicking of the **<8>** key, as shown below:

**PRESS**



**RESULTANT DISPLAY**

CHIME ON

CHIME OFF



READY HH:MM

 **CHIME** indicator lights steadily when “chime on” is selected.



## 4. Electrical Appliance Control

### Control Options and Pushbuttons

The system allows manual or automatic remote control of up to 15 electrical devices (lights, radio/TV, tape recorders, fans etc.). This requires an optional X-10 controller and up to 15 remote X-10 units (see Fig. 2). ON / OFF control codes are communicated via the regular household electrical wiring.

Besides the X-10 units (numbered 1 to 15), it is possible to control a device connected to the PGM output (unit # 00).

The user defines the ON and OFF times via the Scheduler (see Chapter 7 - Scheduler Function). The installer determines which zone sensors will switch the remote controlled appliances on and off. **However, the decision whether the remote controlled appliances will respond as programmed is up to you** (see next table).

**Note:** The X-10 output operates on the entire alarm system and not per partition.

Key	Function
	Manual activation of lights or other household electrical appliances.
	Manual deactivation of lighting or other household electrical appliances.
	Selecting the active automatic control method: <ul style="list-style-type: none"> <li>■ Sensors: Appliances are controlled by sensors (assigned by the installer for this).</li> <li>■ Timer: Appliances are controlled by timer (ON and OFF times are defined by the installer).</li> <li>■ Both: Appliances are controlled by sensors as well as by a timer.</li> </ul>

Examples of benefits gained by automatic remote control:

- **Timer Control.** When you are away, the timed activation / de-activation of lights, radio and TV simulates the presence of people at home, to deter potential burglars.
- **Zone Control.** Upon disturbance of a perimeter zone, lights are switched on and a tape recorder starts running, playing back a series of dog barks.

**Note:** Automatic activation and deactivation of electrical appliances depend also on the Scheduler setup (see Chapter 7 - Scheduler Function).

### Manual Switch-On

You can switch appliances ON as instructed below. This example shows how to switch on the lights controlled by X-10 unit No. 01.

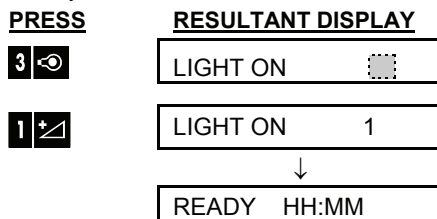

The lights controlled by X-10 unit No. 01 are switched on.

### Manual Switch-Off

You can switch appliances OFF as instructed below. This example shows how to switch off the lights controlled by X-10 unit No. 01.

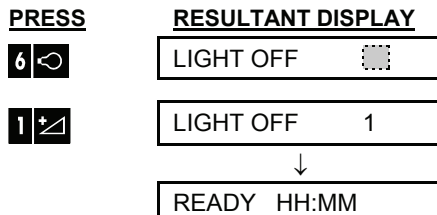

The lights controlled by X-10 unit No. 01 are switched off.

### Light DIM/BRIGHT



Immediately after activating a light (see above - Manual Switch ON), you can dim or brighten it as desired. For this purpose, enable the DIM/BRIGHT function by pressing or (in older versions of the PowerMax Pro), then press several times (as desired) the (DIM) or (BRIGHT) button.

### Automatic ON/OFF Control

You can select two of four options:

- By Timer ON
- By timer OFF
- By sensor ON
- By sensor OFF

# ELECTRICAL APPLIANCE CONTROL

The presently active options are shown with a dark box (■) at the far right. To view the 2 other options click  .

A presently inactive option is shown without a dark box at the far right. The dark box will appear if you click  while the option is displayed. A "Happy Tune" indicates successful saving of a new option.

## PRESS



**If not satisfied -**  
press  

**If satisfied -**  
press



**If not satisfied -**  
Press  

**If satisfied -**



## RESULTANT DISPLAY



(If this is the default)



(If this is the default)

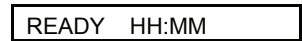
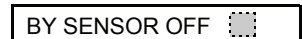
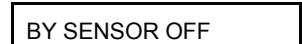

## 5. Reading Alarm Memory And Trouble Data

### Reviewing Alarm/Tamper Memory

The PowerMax Pro retains in its memory alarm and "tamper" events that occurred during the last arming period. **For PowerMax Pro that includes partition option:** In order to review alarm and tamper events of a specific partition, you need to select the desired partition(s), (please refer to Partition Selection Process).

**Note:** Alarms enter the memory only after expiry of the "abort period" (see Appendix A). This means that if you disarm the system immediately - before the abort period expires - there will be no memory indication

#### A. Alarm / Tamper Indications

When the memory contains at least one event and the system is in the disarmed state, a flashing **MEM** message will be displayed, as exemplified:

READY HH:MM

↶ (alternating) ↷

READY MEMORY

or, if the system is not ready for arming -

NOT READY HH:MM

↶ (alternating) ↷

NOT READY MEMORY

#### B. Investigating Alarm/Tamper Data

To review memory content, click  button.

**EXAMPLE 1:** An alarm was triggered because the garage door - zone No. 12 - was opened **but then closed**. In addition, the bedroom motion detector - zone No. 7 - sent a "Tamper" message because its cover had been removed.

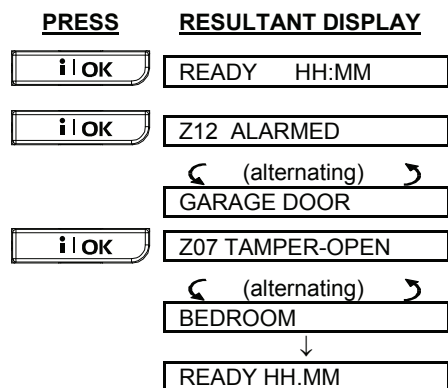

In response to additional clicking of the  button, the display shows details of other events retained in open tamper (if any), or reverts to its initial state (see A above).

**EXAMPLE 2:** An alarm was triggered because the garage door - zone No. 12 - was opened and remained open.

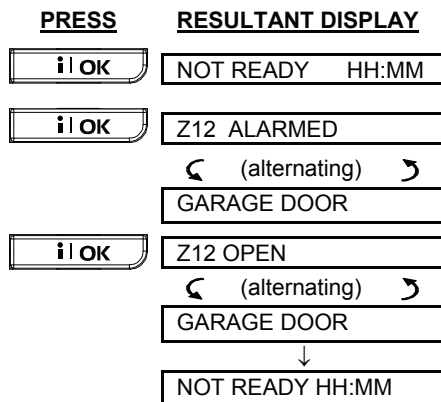

**Remember!** The memory indication and content are cleared upon the next arming of the system.

### Reviewing Trouble Information

#### A. Trouble Indications

If TRBL flashes in the display, the TROUBLE indicator illuminates, and 3 beeps are sounded once per minute, you will have to investigate the system in order to find out the origin and type of trouble.

**For PowerMax Pro that includes partition feature:** The LCD will display the specific partition(s) along with the specific zone number(s) of the location of the trouble indication. The trouble types are as follows:

#### SENSOR TROUBLES

- **Inactivity** - No radio signals have been received from a particular sensor / wireless commander (if its supervision feature has been enabled) during a pre-defined period.
- **Low battery** - The battery in a sensor, keyfob or wireless commander is near the end of its useful life.
- **"Clean me"** - The fire detector must be cleaned.
- **Gas trouble** - Gas detector failure.
- **Siren AC failure** - There is no power to the siren.
- **X-10 trouble** - An activation command was sent to a two-way X-10 unit but the command implementation confirmation (acknowledgement) was not received.
- **AC failure** - There is no power to gas sensor

#### GSM TROUBLES (if used)

- **GSM AC failure** - No power to GSM unit.
- **GSM low battery** - GSM battery voltage is low.
- **GSM tamper** - Someone tampered with the GSM unit.
- **GSM line fail** - GSM telephone line failure.
- **GSM net fail** - GSM network failure.
- **RSSI low** - The GSM received signal strength is low.
- **GSM modem off** - The GSM unit does not operate.
- **GSM communication fail** - There is no communication (RS-232 format) between PowerMax Pro and GSM unit.

# READING ALARM MEMORY AND TROUBLE DATA

## SYSTEM TROUBLES

SYSTEM TROUBLES indicate the state of the entire system and not a specific partition.

- **AC Supply Failure** - There is no power and the system is working on backup battery power.
- **System Jammed** - A radio-frequency signal is blocking communication channel of sensors and control panel.
- **Communication failure** - A message could not be sent to the central monitoring station or to a private telephone (or a message was sent but was not acknowledged).
- **CPU low battery** - The backup battery within the control panel is weak and must be replaced (see Chapter 9 - Replacing Backup Battery).
- **CPU tamper** - The control panel is being tampered with.
- **Fuse Trouble** - The siren fuse is burnt out.
- **Line Failure** - There is a problem with the telephone line

**IMPORTANT!** If the trouble beeps bother you, disarm the system again (even though it is already disarmed). This will cancel the trouble beeps for 4 hours.

## B. Investigating Trouble Sources

In a state of trouble, a flashing TRBL message is displayed as shown in the following examples:

READY HH:MM

↶ (alternating) ↷

READY TRBL

or, if the system is not ready for arming -

NOT READY HH:MM

↶ (alternating) ↷

NOT READY TRBL

You can review the current troubles one by one, by clicking the **i OK** button.

**EXAMPLE:** The kitchen sensor - zone No. 9 in partition 3 - has been inactive and the living room sensor - zone No. 15 in partition 3 - has reported a low battery. However, these troubles do not prevent the system from being "ready to arm".

To investigate the source of trouble, proceed as follows:

PRESS	RESULTANT DISPLAY
<b>i OK</b>	READY HH:MM
<b>i OK</b>	Z09 INACTIVE ↶ (alternating) ↷ KITCHEN
<b>i OK</b>	Z15 LOW BATT ↶ (alternating) ↷ LIVING ROOM ↓ READY HH:MM

In response to further clicking of **i OK**, the display will show details of other troubles (if any), or will revert to the initial alternating displays (see example above).

## Reviewing Memory & Troubles at the Same Time

If **alarms / tamper events** are retained in the alarm memory and at the same time a state of **trouble** exists, the display will behave as shown below for partition 1:

READY HH:MM

↶ (alternating) ↷

READY MEMORY

↶ (alternating) ↷

READY TRBL

or, if the system is not ready for arming -

NOT READY HH:MM

↶ (alternating) ↷

NOT READY MEMORY

↶ (alternating) ↷

NOT READY TRBL

**Note:** When a voice message is in memory, the **MSG** display will also appear (as shown in Chapter 3 - Recording a Message).

To read status information - memory data, open zones and trouble sources (in this order) - click the **i OK** button repeatedly. The memory content will be displayed first, in the same manner shown in Chapter 5 - Reviewing Alarm / Tamper Memory. If the system is not ready, open zone information will follow in the same manner as shown in Chapter 2 - Preparing to Arm. Trouble sources will be displayed last, in the same manner shown in Chapter 5 - Reviewing Trouble Information.

## Correcting Trouble Situations

The trouble indications (illuminated TROUBLE indicator and flashing TRBL message) are cleared once you eliminate the cause for trouble. **If you do not know how to cope with a trouble situation, report it to your installer and seek his advice.**

**INACTIVITY:** Once an inactive wireless device renews its periodical transmissions, the inactivity trouble no longer exists and will no longer be indicated by the control panel.

**LOW BATTERY:** Upon replacing the battery in a wireless sensor in a keyfob or in a wireless commander that reported a low battery, the next transmission made by the relevant sensor will include a "battery restored" message, and "low battery" will no longer be indicated by the control panel.

**SYSTEM TROUBLE:** Correction of any one of the system troubles is automatically sensed by the control panel, and the trouble indication is cleared accordingly.

## 6. Special Functions

### Looking after People Left at Home

An important characteristic of the PowerMax Pro is its ability to function in a mode contrary to the usual behavior of an alarm system. When the system is in the disarmed state (or even when armed "HOME" with perimeter protection only), it can keep track of in-house activity and will report **lack of motion** in interior zones if there is no detection of motion within predetermined time limits.

To use this characteristic, you must ask your installer to program a specific time limit beyond which lack of motion will be reported as a "not active" alert.

To make things clear, let us assume that an elderly, sick or handicapped person is left unattended in a protected site. This person, disabled or sick as he may be, will not stay entirely still for hours. It is only natural that even while being asleep he will turn over in his bed from time to time. He might also wander into the kitchen to eat or drink, or to the bathroom for other necessities. Upon doing so, the bedroom, bathroom and kitchen motion detectors will detect his movement.

If, for example, the "lack of motion" time limit is set by your installer to 6 hours, a virtual 6-hour clock will carry out a 6-hour "countdown".

If motion is detected within the 6-hour time frame, the countdown will restart from the beginning (the virtual 6-hour clock will be "reset") and no alert message will be sent out.

If no motion is detected within the 6-hour time frame in any interior zone, the control panel will send a "not-active" alert message to the central monitoring station or to private telephones designated by the installer.

**IMPORTANT!** In addition, you may provide the person confined to interiors with a single-button transmitter for distress situations, see next paragraph.

### Emergency Calls for Help

Suppose the disabled person discussed above has an accident such as falling in the bathtub without being able to get up. It might take hours before the "No Active" alert is sent out, but he (or she) must be assisted much sooner.

Even though the odds for such an accident are not high, it is advisable to provide the disabled person with a miniature, single-button pendant-type or wristwatch-type transmitter. Pressing the button on this transmitter will cause the PowerMax Pro to send an "emergency call" to the central monitoring station or to private telephones designated by the installer.

To make this possible, ask your installer to define one of the 28 zones of the PowerMax Pro as an emergency zone.

Then, obtain one of the transmitters listed below and link this transmitter's ID code to the emergency zone.

Compatible distress transmitters are (see Fig. 5):

**MCT-201** - pendant-type

**MCT-211** - wristwatch-type

**MCT-101** - pocket-type

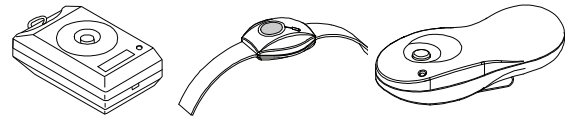

**MCT-201**

**MCT-211**

**MCT-101**

**Figure 5.** Single-button Emergency Transmitters

### Remote Control by Telephone

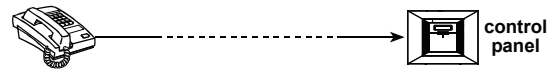

#### A. Establishing Telephone Communication

You can access the PowerMax Pro system from a remote telephone and perform arming and disarming, activation and deactivation of electrical devices and the auxiliary output (PGM), record, playback and erase a voice message, and investigate the system status. The process is shown in the next illustration.

1. Dial the PowerMax Pro tel. No.
2. Wait for 2-4 rings then hang up.
3. Wait 12-30 sec.
4. Redial PowerMax Pro tel. No. (Sound will be heard for 10 sec.).
5. [\*] (to stop the sound) <sup>1</sup>
6. [User code], [#] <sup>2</sup>
7. [Desired command, see next table] <sup>3</sup>

Not applicable when dialing to the GSM number of the PowerMax Pro. Proceed to step 5.

#### Notes:

- (1) The PowerMax Pro responds in a similar way if you just dial once and wait until you hear telephone rings (in USA, for example, 11 rings).
- (2) Entering of user code is required once only.
- (3) If you wait more than 50 seconds (may change according to setup / use) without keying a command, the PowerMax Pro will disconnect the line.

## B. Executable Commands

Command	Keying Sequence	Keying Sequence – PowerMax Pro Partition System
Disarming	[★]→[1]→[#]	[★]→[0]→[partition]→[1]→[#]
Arming Home	[★]→[2]→[#]	[★]→[0]→[partition]→[2]→[#]
Arming Home-Instant	[★]→[2]→[1]→[#]	[★]→[0]→[partition]→[2]→[1]→[#]
Arming Away	[★]→[3]→[#]	[★]→[0]→[partition]→[3]→[#]
Arming Away-Instant	[★]→[3]→[1]→[#]	[★]→[0]→[partition]→[3]→[1]→[#]
Arming Away-Latchkey	[★]→[4]→[#]	[★]→[0]→[partition]→[4]→[#]
Arming Away-Instant-Latchkey	[★]→[4]→[1]→[#]	[★]→[0]→[partition]→[4]→[1]→[#]
Review status of specific partition(*)		[★]→[0]→[partition]→[9]→[#]
Elect. Devices (No. 01-15) ON	[★]→[5]→[device No.]→[1]→[#]	[★]→[5]→[device No.]→[1]→[#]
Elect. Devices (No. 01-15) OFF	[★]→[5]→[device No.]→[0]→[#]	[★]→[5]→[device No.]→[0]→[#]
Activating PGM output	[★]→[5]→[0]→[0]→[1]→[#]	[★]→[5]→[0]→[0]→[1]→[#]
Deactivating PGM output	[★]→[5]→[0]→[0]→[0]→[#]	[★]→[5]→[0]→[0]→[0]→[#]
Two-way voice communication (see sub-par. C)	[★]→[7]→[#]	[★]→[7]→[#]
Recorded message playback	[★]→[8]→[1]→[#]	[★]→[8]→[1]→[#]
Recorded message start record	[★]→[8]→[2]→[#]	[★]→[8]→[2]→[#]
Recorded message stop record	[★]→[8]→[3]→[#]	[★]→[8]→[3]→[#]
Recorded message erase message	[★]→[8]→[4]→[#]	[★]→[8]→[4]→[#]
Investigating system status	[★]→[9]→[#]	[★]→[9]→[#]
Quit (end communication)	[★]→[9]→[9]→[#]	[★]→[9]→[9]→[#]

\* This command operates on ALL permitted partition(s).

## C. Two-Way Voice Communication

Perform steps 1-6 in Establishing Telephone Communication above and continue as follows:

1.  [★]→[7]→[#]

2. Wait for 2 beeps

3.  [3] or [1] or [6] (see below)

The system will start to function in the "LISTEN IN" mode, letting you hear the sounds within your residence for 50 seconds. If the person under

surveillance happens to speak or cry then, you will hear this. You can switch the system to **Listen-In**, **Speak Out** or **Full Duplex**, as shown in the next table.

Command	Key
Listen-in (listening to the person at home) (*)	[3]
Speak-out (speaking to the person at home) (*)	[1]
Full-duplex (listening & speaking) (*)	[6]
<b>Note:</b> To prolong the communication session by 50 seconds, press [3], [1] or [6] again, as required.	



# SPECIAL FUNCTIONS

\* The 2-way communication can be terminated by anyone close to the PowerMax Pro, by disarming the system.



## Remark Regarding Listen-in & Speak-out modes

*Listen-in & Speak-out modes allow one way speech at a time. Back and forth exchange of uninterrupted speech between two parties is a method normally used in military, commercial and amateur radio communication. Once you finish talking you should say "Go Ahead" or "Over" and then switch from speak-out to listen in. When the person at home finishes talking he should also say "Over", as a cue to you to switch back from Listen-in to speak out.*



EXAMPLE:

You (at remote telephone):  [1], "Hey, George, can you hear me? Are you in any trouble? Over"....  
 [3]

Person at home: "Yes, I am. I had a dizzy spell while trying to get out of bed and fell on the floor. I am unable to get up and my thigh hurts. Can you help me? Over"...

You (at remote telephone):  [1], "Sure, I will send someone right away, stay put - over".. [3].

Person at home: "Thanks, please hurry, over".

You (at remote telephone):  [1], "All right, over and out".....  
 [\*]→[9]→[9] (END OF SESSION)

**IMPORTANT!** *If you wish to exit the two-way communication mode and execute another command, just press [\*] and then key your user code followed by the command (see "keying sequences" in Executable Commands table above).*

## Reporting to Private Telephone

control panel



The PowerMax Pro can be programmed by the installer for selective transmission of messages to private telephone subscribers. Messages are divided by type into 4 groups:

Group	Events Reported
1	Fire, Burglary, Panic, Tamper
2	Arming AWAY, Arming HOME, Disarming
3	No-activity, Emergency, Latchkey, Gas, Flood, Temperature
4	Low-battery AC failure

When the called party answers a call initiated by the PowerMax Pro, he will hear a verbal message composed of the "house identity" and the type of event that occurred. For example, once smoke is detected in the Smith residence, the message will be:

[The Smith Residence - Fire Alarm].

If a person under surveillance in the Watkins residence has been inactive, the message will be: [The Watkins Residence - No Activity].

The called party must acknowledge the message (as explained later on), but if he does not respond, the message will be transmitted repeatedly as many times as possible within a 45-second time limit. When the 45 seconds are up, the PowerMax Pro will disengage the line and call the next private telephone number on its list.

The called party can acknowledge the message by pressing a key on the telephone keypad, as follows.

Command	Key
<b>Acknowledge only:</b> The PowerMax Pro disengages the line and considers the event duly reported.	2
<b>Acknowledge and listen-in:</b> The protected site is "bugged" for sound for 50 seconds. The called party may prolong the listening session by pressing [3] again before the PowerMax Pro disengages the line, or by pressing [1] to speak.	3
<b>Acknowledge and speak out:</b> The called party may speak for 50 seconds to whoever is in the protected site. The called party may prolong the "speak out" session by pressing [1] again before the PowerMax Pro disengages the line, or by pressing [3] to listen.	1
<b>Acknowledge and 2-way conversation:</b> You and the called party can speak and listen without any necessity to switch the system from "listen-in" to "speak-out" and vice versa for 50 sec. (extendable).	6
<b>Acknowledge and request a status report:</b> The PowerMax Pro will issue a verbal report of system status. For example: [Disarm - ready to arm] or [Disarm - back door open] or [Disarm - alarm in memory].	9

## Remote Control by SMS

PowerMax Pro system with GSM unit can respond to SMS commands from any cellular telephone.

The various SMS commands are detailed in the following table (the detailed SMS message sending process is described in the cellular telephone user's guide). In this table, "<code>" means 4-digit user code and blank space simply means blank space.

### SMS Command List

In the following table, "P#" is used only for PowerMax Pro with partition feature - use P1, P2, P3, or P4, according to the partition number.

# SPECIAL FUNCTIONS

	Command	SMS Format	SMS format – PowerMax Pro Partition System
1	Arm AWAY	"AWAY <code>" or "AW <code>"	"P# AWAY <code>" or "P# AW <code>"
2	Arm AWAY instant	"AWAY INST <code>" or "AWI <code>"	"P# AWAY INST <code>" or "P# AWI <code>"
3	Arm AWAY Latchkey	"LATCHKEY <code>" or "LK <code>"	"P# LATCHKEY <code>" or "P# LK <code>"
4	Arm AWAY Latchkey instant	"LATCHKEY INST <code>" or "LKI <code>"	"P# LATCHKEY INST <code>" or "P# LKI <code>"
5	Arm HOME	"HOME <code>" or "HM <code>"	"P# HOME <code>" or "P# HM <code>"
6	Arm HOME instant	"HOME INST <code>" or "HMI <code>"	"P# HOME INST <code>" or "P# HMI <code>"
7	Disarm	"DISARM <code>" or "DA <code>"	"P# DISARM <code>" or "P# DA <code>"
8	Turn light xx on (xx = 01 – 15)	"LIGHT xx ON <code>" or "LT xx ON <code>"	"P# LIGHT xx ON <code>" or "P# LT xx ON <code>"
9	Turn light xx off (xx = 01 – 15)	"LIGHT xx OFF <code>" or "LT xx OFF <code>"	"P# LIGHT xx OFF <code>" or "P# LT xx OFF <code>"
10	Turn PGM on	"PGM ON <code>"	"P# PGM ON <code>"
11	Turn PGM off	"PGM OFF <code>"	"P# PGM OFF <code>"
12	Define custom house identity (see note)	"HOUSE NAME <code> <house ID>" or "HN <code> <house ID>"	"P# HOUSE NAME <code> <house ID>" or "P# HN <code> <house ID>"
13	Query system status	"STATUS <code>" or "ST <code>"	"P# STATUS <code>" Or "P# ST <code>"

**Note:** House ID includes up to 16 characters, for example JOHN'S HOUSE.

## Reporting by SMS

The PowerMax Pro system can send SMS messages to a maximum of 4 pre-selected telephone numbers. Example of the reported SMS messages:

- JOHN'S HOME  
\*\*AWAY\*\*
- JOHN'S HOME  
\*\*DISARM\*\*
- JOHN'S HOUSE  
POWERMAX: LOW BATTERY  
GARAGE: LOW BATTERY

- JOHN'S HOUSE  
STATUS MESSAGE 01  
(Event list is displayed)

**Note:** Status messages can be sent only to a calling telephone whose identity number is not blocked by the user!

## Reporting Messages to a Pager





# SPECIAL FUNCTIONS

Since the PowerMax Pro can be programmed to report events to a pager, the user of the pager must be informed on how to interpret the numerical message that his pager displays.

Communication with a pager takes place as follows:

- The PowerMax Pro dials the pager's phone number, waits 5 seconds and sends the numerical message.
- The message transmitted by the PowerMax Pro to the pager is actually a string of digits, as follows:

**[XXXXXXXXXXXXXXXXXXXX] → [YYY] → [OZZ#]**

Pager's PIN No. - Up to 16 digits  
Programmed by the Installer    Event Type    Zone or User No.

**Figure 6.** Pager Message Structure

The person receiving the message sees only the "YYY -OZZ#" part of the message, which he can interpret by using the following legend:

Events types (YYY) are coded as follows:

Event	Code	Event	Code
Alarm	919	Fire	515
Trouble	818	Close	101
Emergency	717	Open	102
Panic	616	Latchkey	103

**ZZ** is the zone number in which the event occurred, or the user number in case of Close, Open and Latchkey events.

**Example 1: Message reads "919-003":**

This means an alarm occurred in Zone No. 3.

**Example 2: Message reads "101-008":**

This means the system was closed (armed) by user No. 8.

## Conducting a Walk-Test

The walk-test is an indispensable operation by which you verify that all detectors function properly, without disturbing the neighbors with loud sirens. The test must be performed **at least once a week**, and should include all detectors in all zones.

Before performing walk-test, all the detectors must be in normal state. Normal state is achieved when no motion is made for at least 2 minutes.

**Note:** During the test period, 24-hour zones will not cause an alarm if violated, but a fire zone will function normally.

A typical test will take place as follows:

- A.** In older versions of the PowerMax Pro, press the test button , then proceed to step C.

In Partition PowerMax Pro, select the desired partition (as described in Chapter 2: Partition Selection Process). For example, for Partition 3 the display will read

P3 RDY HH:MM P

- B.** Click . The display will read:

WALK TEST

- C.** Click the  button, the display will prompt you for your user code:

ENTER CODE

- D.** Enter your code. The siren will sound for 2 seconds and the display will change to:

TESTING

- E.** Walk throughout the protected area and make sure you trigger every detector with no exception (move across the field of view of motion detectors and open/close doors and windows). Each time a detector is triggered:

- The "Happy Tune" will sound,
- The zone name and number will be displayed briefly.

**EXAMPLE 1:** You triggered a **motion detector** in the living room (zone 11). The display will show:

P3 LIVING ROOM



P3 Z11 VIOLATED

After 5 seconds the display will revert to:

TESTING

**EXAMPLE 2:** You opened a **window** in partition 3 in the guest room (zone 13). The display will show:

P3 GUEST ROOM



P3 Z13 OPEN

After 5 seconds the display will revert to:

TESTING



- F.** When done, click the  button repeatedly. The display will show the test results, partition after partition and zone after zone, in ascending numerical order. For example:

P3 GUEST ROOM

↔ (alternating) ↔

P3 Z13 OK

or: "P3 Z13 NOT OK" if there was no response from Z13.

- G.** To resume testing, click . To quit the test mode, click . The display will then read:

<OK> TO EXIT

- H.** Click . The display will revert to its normal state.

## 7. User Settings

### What are the Settings You Need?

The installer provides you with a ready-to-use alarm system, but a few settings and adjustments will still be needed.

**Note:** Although the user settings are your responsibility, you may request your installer to perform them for you (except for the user codes which you would like to keep secret).

The user settings include (if enabled by the installer):

- **Bypassing zones** - determining which zones will be bypassed (disabled) during the present disarm period and the next armed period.
- **Reviewing the bypass list** - "show bypass" - displaying the numbers and names of bypassed zone one by one.
- **Recalling the last bypassing scheme** - "recall bypass" - re-using the previous bypassing scheme, which becomes suspended after disarming but is still saved in the PowerMax Pro memory.

**Note:** RECALL BYPASS is applicable in Non-Partition menu only.

- **Private report\*** - determining the event groups to be reported to private telephone subscribers. Determining the 1<sup>st</sup>, 2<sup>nd</sup>, 3<sup>rd</sup> and 4<sup>th</sup> telephone numbers to which the system will report event messages that were defined by the system installer. Determining the 1<sup>st</sup>, 2<sup>nd</sup>, 3<sup>rd</sup> and 4<sup>th</sup> SMS telephone numbers to which pre-selected event types will be reported.
- **Setting user codes\*** - programming a security code for yourself and additional 7 codes for other system users. Codes 5 through 8 are "Latchkey" user codes (see Chapter 2 - Arming in the Latchkey Mode for additional details).
- **Enrolling keyfob transmitters\*** - teaching the PowerMax Pro system to recognize the ID code of each keyfob transmitter (multi-button, CodeSecure™ type, wireless transmitter), so that the PowerMax Pro can respond to commands transmitted by them.
- **Enrolling proximity tags\*** - teaching the PowerMax Pro to recognize the ID of each proximity tag so that the PowerMax Pro can respond to proximity tags presentation.
- **Setting voice options\*** - enabling or disabling verbal announcements (prompts).
- **Auto arm option\*\*/\*\*** - enabling or disabling automatic arming (at a predefined time).
- **Setting auto arm time\*\*/\*\*** - selecting automatic arming time.
- **Using squawk option\*** - enabling/disabling LOW/MID/HI squawk (short siren sound) upon arming and disarming by keyfob. All the options are applicable for wireless siren. For wired siren, refer to LOW, MID and HI options as "squawk enable".

- **Setting the time and time format\*** - adjusting the built-in clock to show the correct time and time format.
- **Setting the date and date format\*** - adjusting the built-in calendar date and date format.
- **Setting the scheduler\*** - setting schedule for devices start/stop activation.
- **Show log** – enabling or disabling the event log where events are displayed in chronological order - from the newest to the oldest.

\* This option can be accessed only if master user code has been entered.

\*\* This menu is not available when Partition is enabled.

### Entering the User Settings Menu

Figure 7 describes how to enter User Settings menu (when all zones/partitions are secured) for the Partition and non-Partition system.

Click the keys that you are instructed to press. The resultant display is shown below each instruction.

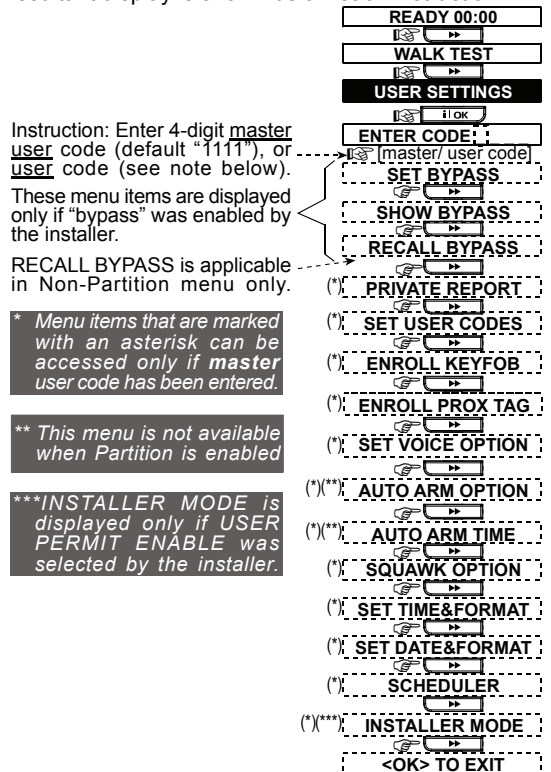

**Figure 7 – Entering User Settings Menu**

The following paragraphs include User Settings step-by-step instructions. However, if you want to get an overall view of the entire User Settings menu, refer to figure 8 - User Setting flow-chart. You can use the flow chart as your only guide through the user settings process instead of going through the step-by-step instructions.

# USER SETTINGS

## Bypassing Zones

### A. General Guidance

You can program the PowerMax Pro to exclude (bypass) selected zones, regardless of whether these zones are "functional" (undisturbed) or "open" (disturbed). Bypassing permits free movement of people within certain zones although the system is armed. It is also used to temporarily remove from service faulty zones that require repair work. Fire and temperature zones can not be bypassed.

Remember – zone bypassing compromises security!  
**Note:** Zones will be bypassed throughout one disarm-arm period only. Disarming the system after arming will suspend the entire bypassing scheme.

### B. Bypassing Procedure

For PowerMax Pro with partition feature, you may set the bypass option according to the type of partition access permission.





Having entered your user code successfully (see above - Entering the User Settings Menu), the display will read:



SET BYPASS

If at this point you click , the number and state of the first zone / partition containing the first zone (in PowerMax Pro with partition feature) will be automatically displayed. Three states are then made possible:

- **Open:** The zone is not secured - you can bypass the zone if you do not wish or know how to solve the problem right away.
- **Bypassed:** The zone is presently bypassed (you bypassed it before but have not armed the system yet).
- **Functional:** If there is nothing wrong with the zone, its state is described as "Functional".

Let us assume that Zone 1 in partition 3 is "open" and you wish to bypass it, and the rest of the zones are functional.

PRESS	RESULTANT DISPLAY
	Z01 OPEN ↶ (alternating) ↷ KITCHEN
	<OK> TO BYPASS
	Z01 BYPASSED ↶ (alternating) ↷ KITCHEN
 (if you wish to check the state of the next zone)	Z02 FUNCTION ↶ (alternating) ↷ FRONT DOOR
	SET BYPASS

You can select any other item on the USER SETTINGS menu or quit programming by clicking . When <OK> TO EXIT is displayed - click  button.



At the end of the bypassing operation, **BYPASS** blinks:



READY BYPASS or NOT READY BYPASS



This indication will persist as long as the system remains disarmed, and will disappear once the system is armed.

**Note:** **BYPASS** will alternate in the display with other messages, such as: **TRBL**, **MEM** and **MSG**.

### C. "Unbypass" Procedure



Suppose you wish to restore zone 22 of partition 3 after having completed the bypassing scheme. Simply re-enter the SET BYPASS menu (see Bypassing Procedure above), and click  or  until the zone you wish to "unbypass" in the desired zone/partition is displayed. Refer to the following steps.





PRESS	RESULTANT DISPLAY
	Z22 BYPASSED ↶ (alternating) ↷ LIVING ROOM
	<OFF> TO CLEAR
	Z22 FUNCTION ↶ (alternating) ↷ LIVING ROOM

You may now click  and then select any other item on the USER SETTINGS menu, or click  to quit programming. When <OK> TO EXIT appears - click .

### Reviewing the Bypassed Zone List

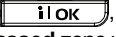
Having entered your user code successfully (see above - Entering to the User Settings Menu), the display will read:

PRESS	RESULTANT DISPLAY
Enter user code	SET BYPASS
	SHOW BYPASS
	BYPASS LIST

If at this point you click , the number, state and name of the first **bypassed** zone will be displayed. You can now click  repeatedly to review all bypassed zones, in ascending numerical order. When done, clicking  will get you back to **SHOW BYPASS** and clicking  will get you back to <OK> TO EXIT.

## Recalling the Last Bypass Scheme

Arming the alarm system with several zones in the bypassed state is in fact "**partial arming**". An identical partial arming may be repeated by recalling the last bypassing scheme (that was suspended and memorized upon disarming the system).

Having entered your user code successfully (see above - Entering to the User Settings Menu), the display will read:

**PRESS**                      **RESULTANT DISPLAY**

Enter user code              SET BYPASS



RECALL BYPASS

At this point proceed as follows:

**PRESS**                      **RESULTANT DISPLAY**

**i OK**                      <OK> TO RECALL

**i OK**                      RECALL BYPASS

You may now select any other item on the USER SETTINGS menu or quit programming by clicking . When <OK> TO EXIT is displayed - click .

## Programming 4 Telephone Numbers

Here you determine the 1<sup>st</sup>, 2<sup>nd</sup>, 3<sup>rd</sup> and 4<sup>th</sup> telephone numbers to which the system will report event messages that were defined by the system installer. You can ask the installer to set some or all of the four telephone numbers.

Having entered your Master User Code successfully (see above - Entering the User Settings Menu), click button repeatedly (if necessary) until the display will read:

SET PHONE NUMBER

You are allowed to program the 4 numbers as follows:

**PRESS**                      **RESULTANT DISPLAY**

                     1st private tel#

                     XXXXXXXXXX

[Enter Tel. No.]              XXXXXXXXXX

                     XXXXXXXXXX

                     1st private tel#

             2nd private tel#

Continue the same way up to telephone number 4. You may now switch to any other item on the USER SETTINGS menu or quit programming by clicking until <OK> TO EXIT is displayed and then clicking .

## Setting the User Codes

Having entered your Master User Code successfully (see above - Entering the User Settings Menu), click until the display reads:

SET USER CODES

**User Code 1** replaces the factory default master user code, and should be assigned to the master user of the system. This code can not be erased.

**User Codes 2, 3** and **4** can be assigned to additional users - family members, co-workers etc.

**Codes 5 through 8** are assigned to "Latchkey Users" (see Chapter 2 - Arming in the Latchkey Mode, for an explanation of the latchkey mode).

**Caution! Code "0000" is not valid! Do not use it.**

*Note: The duress code set by the installer (2580 by default) cannot be selected as a normal user code. Any attempt to program it will be rejected by the PowerMax Pro.*

Master user code is valid for all 4 system partitions. In PowerMax Pro with partition feature, user codes 2 -8 are valid for predefined partitions only.

User codes programming process is as follows:

**PRESS**                      **RESULTANT DISPLAY**

Programming user code 1 (master user code)

                     user code 1: \_\_\_\_\_

                     user code1: 1 1 1 1

[4-digit user code] e.g. 6854                      user code 1: 6854

                     user code 1: 6854

Programming user codes 2 -8 and assigning them to the desired partitions

                     user code 2

                     user code 2: 1 1 1 1

[4-digit user code] e.g. 9854

In PowerMax Pro Partition systems

                     access to part

                     U02: 1 2 3 4

# USER SETTINGS

Enter partition numbers (eg. 2&4 enter 24)

U02: 1 2 3 4

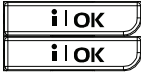

Continue the same way up to Code 8 and press to return to SET USER CODES menu.

You may now select any other item on the USER SETTINGS menu or quit programming by clicking .

When <OK> TO EXIT is displayed - click .

## Enrolling Keyfob Transmitters

Eight system users carry keyfob transmitters to exercise better, quicker and safer system functions control. Your control panel must recognize the unique identification code (ID) of each such keyfob to respond to commands transmitted by them.

Before anything else, gather up all keyfob units you intend to enroll, and make sure they all have batteries installed. Keyfob transmitter enrolling involves the following steps:

A. Having entered your Master User Code successfully (see above - Entering the User Settings Menu), Click the (repeatedly, if necessary) until the display will read:

ENROLL KEYFOB

B. Click . The display will read:

KEYFOB No: \_

C. Suppose that the Keyfob you are about to enroll is to be designated as Keyfob No. 5. Assuming that memory location No. 5 is free - no keyfob has yet been enrolled to it - click the <5> key. The display will change to:

KEYFOB No: 5

The clear space at the far right tells you that the memory location is free.

D. Click . The display will prompt you to initiate a transmission from the chosen keyfob:

TRANSMIT NOW

E. Initiate a transmission from the chosen keyfob by pressing any one of its pushbuttons. In response, the "Happy Tune" (- - - —) will sound. For disabled partitioning mode, the display will be:

KEYFOB No: 5

Proceed to step "J" below.

For enabled partitioning mode, the display will be:

F05: PARTITION

F. Click . The display will be:

PARTITION 1

G. Select the next partition by pressing .

The display will be:

PARTITION 2

H. Click . The display will be:

PARTITION 2

I. Click . The display will be:

KEYFOB No: 5

A dark box will appear at the far right, indicating that the chosen Keyfob has been enrolled as Keyfob No. 5.

J. From this point on, you may continue in several different directions:

- If you wish to enroll another keyfob, select the desired number by:

- Clicking to go up (6→7→8....)

- Clicking to go down (4→3→2....)

- Clicking → <keyfob #>.

- To return to the main menu, click . This will bring back the display:

<OK> TO EXIT

You may now review and select any other mode on the User menu (by clicking or .

## Deleting Keyfob

Occupied keyfob memory locations must be cleared (enrolled ID must be deleted) before enrolling a new ID. To delete an existing ID, proceed as follows:

A. Select the desired memory location, as described in the previous paragraph, steps A-C. If, for example, you selected **keyfob No. 5**, the display will read:

Keyfob No. 5

B. Click . The display will change to:

<OFF> to delete

C. Click . The display will change to:

Keyfob No. 5

Note that the dark box at the far right has disappeared. It is now possible to enroll a new ID. It is also possible to leave the cleared keyfob location free and simply exit to the main menu.

## Enrolling Proximity Tags

**Note for PowerMax Pro with partition feature:** Each proximity tag assigned to a partition will function as determined in "Setting the User Codes". Therefore, each proximity tag must be assigned a relevant user code. For example, proximity tag 3 is assigned to user code 3.

Up to 8 proximity tags can be enrolled to the PowerMax PRO.

Proximity tag enrolling involves the following steps:

- A. Having entered your Master User Code successfully (see Entering the User Settings Menu), Click the  button (repeatedly, if necessary) until the display will read:

ENROLL PROX TAG

- B. Click . The display will read:

Tag No: 1





- C. Click . The display will prompt you to initiate a transmission from the chosen tag:

PRESENT TAG



- D. Present the tag to the control panel left bottom side. In response, the "Happy Tune" (- - - —) will sound and the display will change to:

Tag No: 1 

A dark box will appear at the far right, indicating that the chosen tag has been enrolled.

- E. Click  and enroll the next proximity tag (2, 3,...8), as described in step D.
- F. From this point on, you may continue in several different directions:
- If you wish to enroll another tag, select the desired number by:
    - Clicking  to go up (6→7→8.....)
    - Clicking  to go down (4→3→2.....)
    - Clicking  → <tag#>.
  - To return to the main menu, click . This will bring back the display:

< OK > TO EXIT

You may now review and select any other mode on the User menu (by clicking  or .

# USER SETTINGS

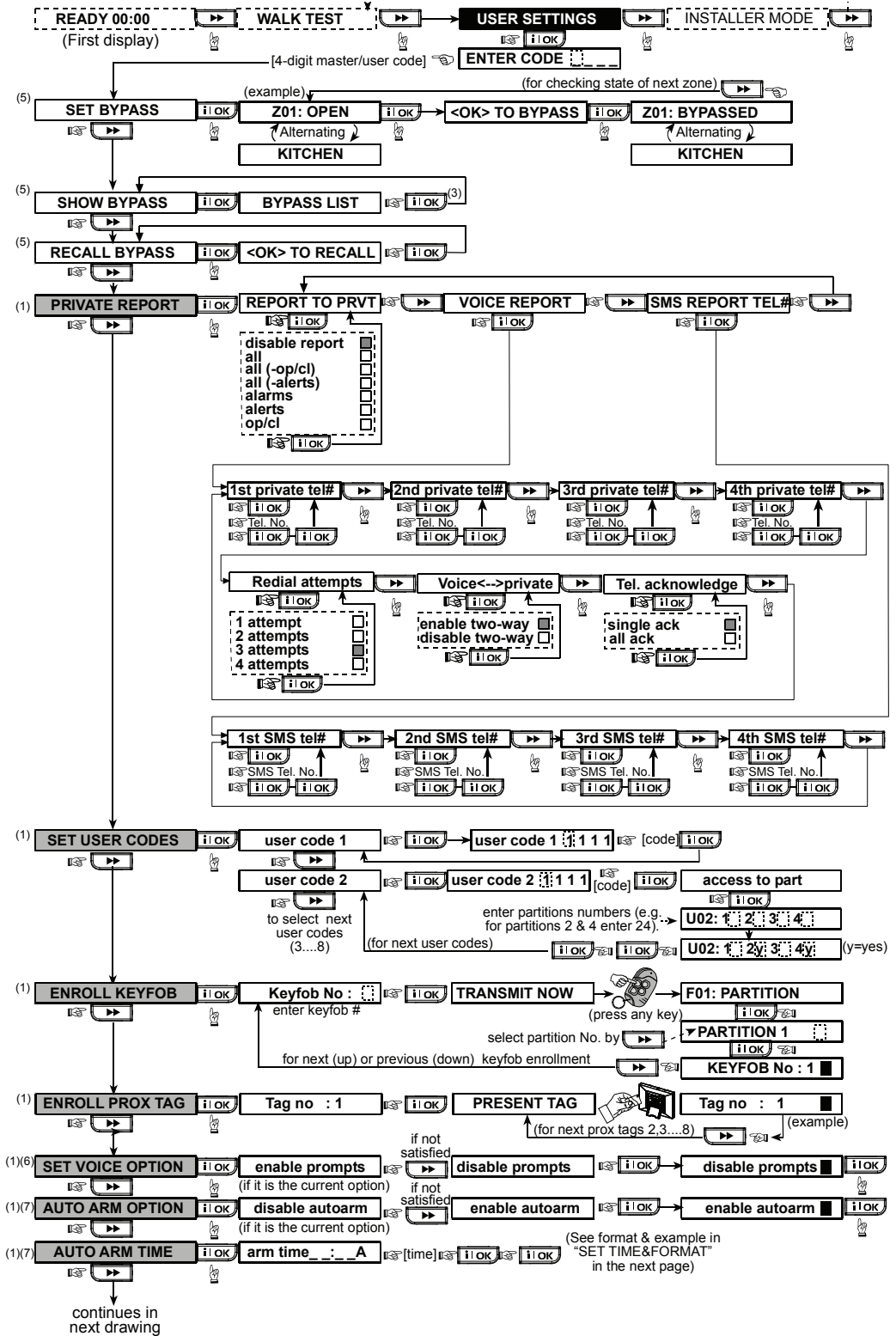

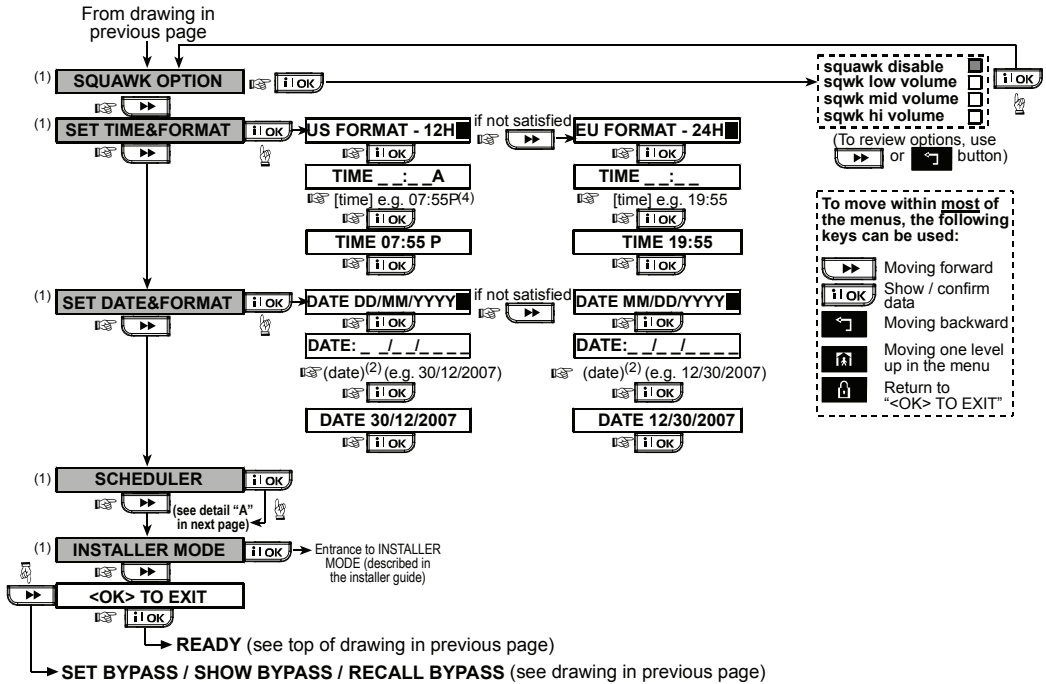

**Figure 8 - Users Settings Flow Chart**

- Notes:
- (1) Functions inside black rectangles are accessible only if master user code was entered.
  - (2) For the year, enter the two last digits only.
  - (3) Press *i OK* to display the number, state and name of first bypassed zone. Press *i OK* repeatedly to view all the bypassed zones.
  - (4) To enter "A" (AM) press *i OK* (or one of the 3 keys above it), to enter "P" (PM) press *i OK* (or one of the 3 keys above it).
  - (5) SET/SHOW/RECALL BYPASS menus are accessible only if "manual bypass has been selected by the installer.
  - (6) In the SET VOICE OPTION, if you select "enable prompts", the Control Panel mute speaker button *i OK* is active.
  - (7) This menu is not available when partition is enabled.

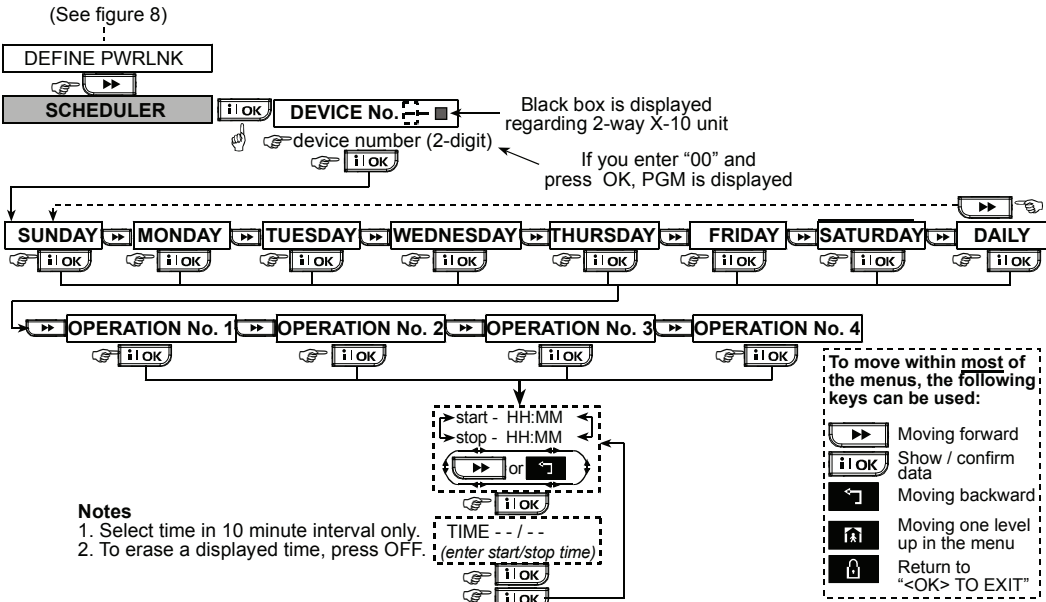

**Figure 8 DETAIL "A" - Scheduler Function**



# USER SETTINGS

## Deleting Proximity Tags

Proximity tag memory locations must be cleared (enrolled ID must be deleted) before enrolling a new ID. To delete an existing ID, proceed as follows:

A. Select the desired memory location, as described in the previous paragraph, steps A-C. If, for example, you selected **Tag No. 5**, the display will read:

Tag No. 5

B. Click . The display will change to:

<OFF> TO DELETE

C. Click . The display will change to:

Tag No. 5

Note that the dark box at the far right has disappeared. It is now possible to enroll a new ID. It is also possible to leave the cleared zone or memory location free and simply exit to the main menu.

## Setting the Voice Options

**Remember:** Voice prompts are heard over the built-in loudspeaker subject to two conditions:

- The voice option is enabled as shown below
- The loudspeaker is enabled by pressing the "7" key (see Chapter 3 - Voice ON-OFF)

Here you may select one of two options:

**Enable prompts:** Voice announcements

**Disable prompts:** No voice announcements

The presently programmed option will be shown, with a dark selection box (■) at the far right of the display. You may view the other option (that does not have a dark box at the far right) by clicking . A dark box will appear if you click while the other option is displayed.

To set the voice option, proceed as follows:

Having entered your Master User Code successfully (see above - Entering the User Settings Menu), click the button until the display reads:

SET VOICE OPTIONS

From here, proceed as follows:

**PRESS**                      **RESULTANT DISPLAY**

                     enable prompts (if this is the current option)

If not satisfied  
                      disable prompts

If satisfied -  
                      disable prompts

                     SET VOICE OPTION

You may now select any other item on the USER SETTINGS menu or quit programming by clicking . When <OK> TO EXIT is displayed – click .

**Note:** When using the MCT-234 or MCT-237 keyfob with the PowerMax Pro, the voice prompts must be enabled.

## Automatic Arming Option

**Note:** This menu is valid when operating in non-partition mode only.

You can determine that the system will be automatically armed at any desired time.

Having entered master user code successfully, click until AUTO ARM OPTION is displayed.

From here, proceed as follows:

**PRESS**                      **RESULTANT DISPLAY**

                     enable autoarm (if this is the current option)

If not satisfied  
press  
                      disable autoarm

                     disable autoarm

                     AUTO ARM OPTION

You may now select any other item on USERS SETTINGS menu or quit programming process by clicking . When "<OK> TO EXIT" is displayed, click .

## Setting Arming Time

**Note:** This menu is valid when operating in non-partition mode only.

Having entered your Master User Code successfully (see above - Entering the User Settings Menu), click button (repeatedly, if necessary) until the display will read:

AUTO ARM TIME

From here, proceed as follows:

**PRESS**                      **RESULTANT DISPLAY**

                     arm time \_ : \_ A

[time digits] (e.g. 12:55 A)                      arm time 12:55 A

                     arm time 12:55 A

                     AUTO ARM TIME

**Notes:**

- For 12h/24h time format selection, refer to Setting Time and Time Format below.
- Press "\*" to enter A (AM), or press "#" to enter P (PM).

## Enabling the Squawk Option

You can determine that the system will activate (or not activate) high/mid/low wireless siren sound, for a short time, upon arming (1 beep) and disarming (2 beeps), by keyfob only.



Having entered your Master User Code successfully (see above - Entering the User Settings Menu), click the  button (repeatedly, if necessary) until the display will read:

SQUAWK OPTION



From here, proceed as follows:

**PRESS**



**RESULTANT DISPLAY**

 squawk disable   
(if this is the current option)



If not satisfied -

  squawk low volume



If not satisfied -

  squawk mid volume



If not satisfied

  squawk hi volume

If satisfied

  squawk hi volume 

For wireless siren, refer to "low", "mid" and "hi" options as "squawk enable".

You may now select any other item on the USERS SETTINGS menu or quit the programming process by clicking . When "<OK> TO EXIT" is displayed, click .

## Setting Time and Time Format

Having entered your Master User Code successfully (see Entering the User Settings Menu, above), click  until the display reads:

SET TIME&FORMAT

**A. If 12h format is desired, continue as follows:**

**PRESS**      **RESULTANT DISPLAY**

 US FORMAT - 12H  
(if this is the current option)

 TIME : A

 (time digits] (e.g. 12:55A)

 TIME 12:55A

 TIME HH:MM A

**Note:** To enter "A" - press [\*] or to enter "P" - press [#].

**B. If 24h format is desired, continue as follows:**

**PRESS**      **RESULTANT DISPLAY**

 US FORMAT - 12H

 EU FORMAT - 24H



 TIME :

 [time digits] (e.g. 19:55)

 TIME 19:55

 TIME 19:55

 TIME HH:MM

You may now select any other item on the USER SETTINGS menu or quit programming by clicking . When "<OK> TO EXIT" is displayed - click .

## Setting the Date and Date Format

Having entered your Master User Code successfully (see above - Entering the User Settings Menu), click  button (repeatedly, if necessary) until the display will read SET DATE&FORMAT.

From here, proceed as follows:

**PRESS**      **RESULTANT DISPLAY**

 DATE MM/DD/YYYY

If not satisfied press

 DATE DD/MM/YYYY

 DATE \_ / \_ / \_

[Enter date] (e.g. 01/01/2002)

 DATE 01/01/2002

 DATE 01/01/2002

 DATE DD/MM/YYYY

## USER SETTINGS

You may now select any other item on the USER SETTINGS menu or quit programming by clicking



. When <OK> TO EXIT is displayed - click



### Scheduler Function

The Scheduler enables to start and stop activity of the desired devices. You can select the day (Sunday, Monday, Tuesday, Wednesday, Thursday, Friday, Saturday, or daily) and then select the scheduled activity start/stop of the desired device. The process is demonstrated in "figure 8 DETAIL A".

## 8. Reading The Event Log

### Event Log Description

All events are memorized in an event log that contains up to 100 entries. You can access this log, review the events one by one and draw functional conclusions.

If the event log fills up completely it continues to accept new events at the expense of old events - the oldest event is deleted upon registration of each new event.

The date and time of occurrence are memorized for each event. When reading the event log, events are shown in chronological order - from the newest to the oldest.

Because of the limited display space, the event description is shown first, then the date and time. The two displays are shown alternately several times, until you click **i OK** to move on to an older event, or until the "no action" 4-minute timeout restores the system to the normal operating mode.

Access to the event log is provided by clicking the asterisk (★) key and then keying your master user code.

**Should you wish to get an overall view of using the log, refer to Figure 9. The flow chart may even serve as your only guide to using the event log, instead of going through the written step-by-step procedure.**

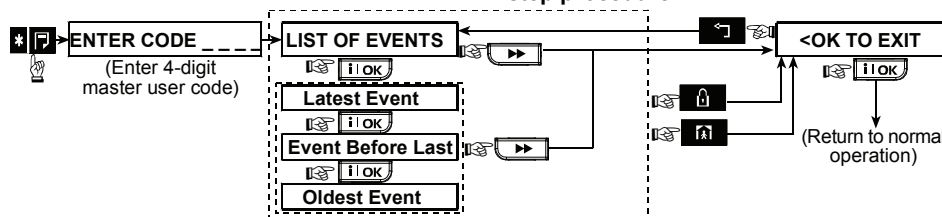

Figure 9. Using the Event Log

### Reading Procedure

To read the event log, proceed as follows:

A. While the system is in the normal operating mode, click the asterisk (★) key. The display will change to:

ENTER CODE \_ \_ \_ \_

B. Enter the current master user code. If the code is correct, the "Happy Tune" will sound and the display will read:

LIST OF EVENTS

**IMPORTANT!** Entering an incorrect code 5 times in a row will initiate a 30-second penalty lockout of the keypad.

C. Click **i OK**. The latest event will be shown. Suppose that the latest event was an alarm in zone 13. The display will now read (if partition is enabled):

PRT: 1 ■ 2 ■ 3 ■ 4 ■  
 (alternating)  
 Z13 ALARM  
 (alternating)  
 09 / 02 / 99 3:37 P

The two displays will be shown alternately until you click **i OK** again to move to the next event, or until the event log times out (4 minutes).

D. Click **i OK** as many times as necessary to read all the data you need.

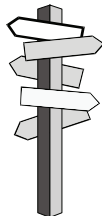

To quit the event log:

- Click **★** or **🔒** from anywhere within the log. The display will read:

<OK> TO EXIT

- Click **i OK**. The system will return to the normal operating mode.

## 9. Maintenance

### Replacing the Backup Battery

The PowerMax Pro uses regular electrical supply, but incorporates backup 9.6V battery pack (see sticker on battery cover). Upon receiving the following trouble message when reviewing system troubles (see Chapter 5 - Reviewing Trouble Information), contact your installer for instructions on how to proceed:

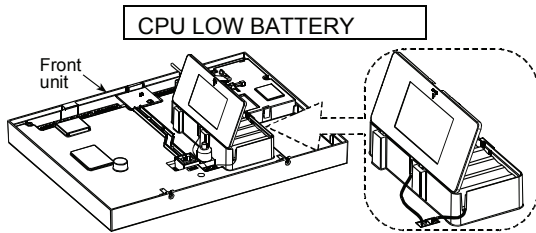

**Figure 10. Battery Replacement**

Open battery compartment cover. Insert one 8-battery pack and connect its connector to the PowerMax Pro receptacle.

**For optional two 8-Battery packs:** Insert both battery packs and connect one battery pack connector to either receptacle and the second battery pack connector to the other receptacle.

**Note:** Dispose of used backup batteries according to the manufacturer's instructions.

**Note:** Removing the cover starts a **Tamper** alarm. The trouble indicator will light and both **Memory** and **Trouble** will flash in the display window. If you view the display at this stage by clicking the  key, the "**CPU TAMPER ALARM**" and "**CPU TAMPER OPEN**" messages are displayed in addition to the "**CPU LOW BATTERY**" message.

When you correctly insert fresh batteries and close the lid tightly, the **TROUBLE** indicator shuts off. The **MEMORY** message continues blinking in the display (because of the **Tamper** alarm you triggered). Clear it by arming the system and disarming it as soon as the exit delay starts.

### Replacing Wireless Sensors Batteries

The **wireless sensors** supplied with your system are powered by high-capacity lithium batteries that last several years, depending on the number of times the sensor is triggered into transmission.

However, if and when a battery becomes weak, the sensor itself sends a "low battery" message to the control panel, and a low battery trouble message is displayed together with the zone information (see Chapter 5 - Reviewing Trouble Information).

The **keyfob transmitters** used to control the system are powered by an alkaline battery that lasts about one year if you do not press a button more than 10 times a day. Battery exhaustion is clearly evident by flashing of the transmitter's red indicator while the button is pressed (instead of lighting steadily).

When a low battery indication appears for the first time, it may be considered as a pre-warning. It normally gives you ample time (about 30 days) to obtain a new battery and replace the old one; the detector or keyfob unit will be fully operational throughout this period. However, to be on the safe side, it is advisable not to wait that long.

Use the battery specified in the detector's own installation instructions. If you do not have the instructions, seek the advice of your installer or ask him to replace the battery in the specific sensor that sent the low battery message.

The **Wireless Commander** is powered by a long life 3 V Lithium battery. If the battery is weak when reading the PowerMax Pro event log the display will read, for example, "C01 Low Battery" (meaning there is a low battery condition in the wireless commander #01), and the message "remote commander" will be heard.

For replacing the wireless commander battery, refer to the MCM-140+ Wireless Commander user guide.

After battery replacement, the detector unit will send a "battery restored" signal to the control panel, and the "low battery" message will be cleared.

### Periodic Testing

The components of your security system are designed to be maintenance-free as much as possible. Nevertheless, it is mandatory to perform a "walk-test" at least once a week and after an alarm event to verify that all system detectors function properly. Proceed as described in Chapter 6 - Conducting a Walk-Test, and if there is any problem, notify your installer at once.

### Cleaning the Control Panel

The control panel may occasionally get stained if touched with greasy fingers, and may accumulate dust after a long period of use. Clean it only with a soft cloth or sponge moistened lightly with a mixture of water and mild detergent, and then wipe it dry.

The use of abrasives of any kind is strictly forbidden. Also never use solvents such as kerosene, acetone or thinner. These will certainly ruin the external finish and damage the transparency of the top window.

## 10. Performance Limits

Although the alarm control system you purchased is highly reliable, it does not guarantee protection from burglary and fire hazards. Even the most advanced systems can be defeated or might occasionally fail to warn. Some of the reasons for this are:

**Sloppy maintenance:** If the system is used over a long period of time without testing, a key element such as a detector or a siren might go wrong without any visible or audible signs of failure. If a low battery warning is neglected, there will be no backup power to keep the system operational during a power outage.

**Power failures:** In case of prolonged absence from the protected site, the mains supply may suddenly fail (an earth leakage protection relay may trip, disconnecting the mains supply). After such an event, the alarm system will draw power from the backup battery, until all reserve power is exhausted, leaving the premises without protection.

**Telephone line trouble:** Telephone lines may be disconnected or short circuited. With the telephone line "down", your alarm system will not be able to report events to the central station.

**Sirens do not always wake up sound sleepers:** Sirens and bells installed outside or far from bedrooms are not likely to awaken people who are sound asleep behind closed doors inside the protected area or in adjacent buildings.

**The system is sometimes defeated:** With sufficient technical know-how, intruders may find a way to defeat various types of sensor or disconnect warning devices. Intruders may also take advantage of unprotected openings and skylights, or even enter forcibly at unpredictable spots.

**Smoke detectors have their limits:** In many cases, smoke detectors fail to warn on time because the fire started at a different level of the house, or too far away from the detector.

**All this gives sufficient proof that even with a good alarm system installed, there is still need for life and property insurance. In addition, users should test their alarm systems at regular intervals, to make sure that malfunctions are detected before a true alarm event occurs.**

## APPENDIX A. GLOSSARY

This list of terms is arranged in alphabetical order. Any term indicated by cursive (italic) letters within the explanatory text can be looked up separately.

**Abort Period:** When an alarm is initiated, the internal sounder is activated first for a limited period of time which is the abort period set by the installer. If you cause an alarm accidentally, you can disarm the system within the abort period before the real sirens start and before the alarm is reported to the *remote responders*.

**Alarm:** There are 2 kinds of alarm:

Loud alarm - both internal and external sirens blare out constantly and the control panel reports the event by telephone.

Silent alarm - the sirens remain silent, but the control panel reports the event by telephone.

A state of alarm is caused by:

- Motion detected by a *motion detector*
- Change of state detected by a *magnetic contact detector* - a closed window or door is opened
- Detection of smoke by a *smoke detector*
- *Tampering* with any one of the detectors
- Pressing the two emergency buttons simultaneously (panic)

**Arming:** Arming the alarm system is an action that prepares it to sound an alarm if a zone is "violated" by motion or by opening a door or window, as the case may be. The control panel may be armed in various modes (see *AWAY*, *HOME*, *INSTANT* and *LATCHKEY*).

**AWAY:** This type of arming is used when the protected site is vacated entirely. All zones, *interior* and *perimeter* alike, are protected.

**Chime Zones:** Allow you to keep track of activity in the protected area while the alarm system is in the disarmed state. Whenever a chime zone is "opened", the buzzer beeps twice. The buzzer doesn't beep, however, upon closing the zone (return to normal). Residences can use this feature to annunciate visitors or look after children. Businesses can use it to signal when customers enter the premises or when personnel enter restricted areas.

**Note:** *Your installer will never designate a 24-hour zone or a fire zone as a chime zone, because both zone types actuate an alarm if disturbed while the system is in the disarmed state.*

Although one zone or more are designated as chime zones, you can still enable or disable the chime function.

**Control Panel:** The control panel is a cabinet that incorporates the electronic circuitry and microprocessor that control the alarm system. It collects information from various sensors, processes it and responds in various ways. It also includes the user-interface - control keys, numerical keypad, display, sounder and loudspeaker.

**Disarming:** The opposite of arming - an action that restores the control panel to the normal standby state. In this state, only *fire and 24-hour zones* will sound an alarm if violated, but a "*panic alarm*" may also be initiated.

**Disturbed Zone:** A zone in a state of alarm (this may be caused by an open window or door or by motion in the field of view of a motion detector). A disturbed zone is considered "not secured".

**Forced Arming:** When any one of the system zones is *disturbed* (open), the alarm system cannot be armed. One way to solve this problem is to find and eliminate the cause for zone disturbance (closing doors and windows). Another way to deal with this is to impose **forced arming** - automatic de-activation of zones that are still *disturbed* upon termination of the exit delay. Bypassed zones will not be protected throughout the arming period. Even if restored to normal (closed), bypassed zones will remain unprotected until the system is disarmed.

Permission to "force arm" is given or denied by the installer while programming the system.

**HOME:** This type of arming is used when people are present within the protected site. A classic example is night-time at home, when the family is about to retire to bed. With HOME arming, perimeter zones are protected but interior zones are not. Consequently, motion within interior zones will be ignored by the control panel, but disturbance of a perimeter zone will cause an alarm.

**Instant:** You can arm the system AWAY-INSTANT or HOME-INSTANT, thereby canceling the entry delay for all delay zones for the duration of one arming period.

For example, you may arm the control panel in the HOME-INSTANT mode and remain within the protected area. Only perimeter protection is active, and if you do not expect somebody to drop in while the system is armed, alarm upon entry via the main door is an advantage.

To disarm the system without causing an alarm, use your control keypad (which is normally accessible without disturbing a perimeter zone) or use a keyfob transmitter.

**Latchkey:** The Latchkey mode is a special arming mode in which designated "latchkey users" will trigger a "latchkey message" to be sent to a telephone or a pager when they disarm the system.

For example, if a parent wants to be sure that their child has returned from school and disarmed the system. Latchkey arming is only possible when the system is armed in the AWAY mode.

**Magnetic Contact Detector, Wireless:** A Magnet-controlled switch and a wireless PowerCode transmitter in a shared housing. The detector is mounted on doors and windows to detect changes in state (from closed to open and vice versa). Upon sensing that a door or window is open, the detector transmits its unique identification code accompanied by an "alarm" signal and various other status signals to the control panel. The control panel, if not armed at that time, will consider the alarm system as "not ready for arming" until it receives a "restored" signal from the same detector.

**Motion Detector, Wireless:** A passive Infrared motion sensor and a wireless PowerCode transmitter in a shared housing. Upon sensing motion, the detector transmits its unique identification code, accompanied by an alarm signal and various other status signals to the control panel. After transmission, it stands by to sense further motion.

**Non-Alarm Zone:** Your installer can designate a zone for roles other than alarm. For instance, a motion detector installed in a dark stairway may be used to switch on lights automatically when someone crosses the dark area. Another example is a miniature wireless transmitter linked to a zone that controls a gate opening mechanism.

**Quick Arming:** Arming without a user code. The control panel does not request your user code when you press one of the arming buttons. Permission to use this arming method is given or denied by the installer while programming the system.

**Remote Responder:** A responder can be either a professional service provider to which the home or business owner subscribes (a *central monitoring station*) or a family relation/friend who agrees to look after the protected site during absence of its occupants. The *control panel* reports events by telephone to both kinds of responders.

**Restore:** When a detector reverts from the state of alarm to the normal standby state, it is said to have been "restored".

A *motion detector* restores automatically after detection of movement, and becomes ready to detect again. This kind of "restore" is not reported to the remote responders.

A *magnetic contact detector* restores only upon closure of the protected door or window. This kind of "restore" is reported to the remote responders.

**Smoke Detector, Wireless:** A regular smoke detector and a wireless PowerCode transmitter in a shared housing. Upon detection of smoke, the detector transmits its unique identification code accompanied by an alarm signal and various status signals to the *control panel*. Since the smoke detector is linked to a special *fire zone*, a fire alarm is initiated.

**User Codes:** The PowerMax Pro is designed to obey your commands, provided that they are preceded by a valid security access code. Unauthorized people do not know this code, so any attempt on their part to *disarm* or defeat the system is bound to fail. Some operations, however, can be carried out without a user code as they do not degrade the security level of the alarm system.

**Zone:** A zone is an area within the protected site under supervision of a specific detector. During programming, the installer allows the *control panel* to learn the detector's identity code and links it to the desired zone. Since the zone is distinguished by number and name, the control panel can report the zone status to the user and register in its memory all the events reported by the zone detector. Instant and delay zones are "on watch" only when the control panel is armed, and other (*24-hour*) zones are "on watch" regardless of whether the system is armed or not.

## APPENDIX B. HOME FIRE ESCAPE PLANNING

Fire can spread rapidly through your home, leaving you a short time to escape safely. Your ability to get out depends on advance warning from smoke detectors and advance planning - a home fire escape plan that everyone in your family is familiar with and has practiced.

- Pull together everyone in your household and make an evacuation plan.

- Draw a floor plan of your home, showing two ways out of each room, including windows. Don't forget to mark the location of every smoke detector.

Test all smoke detectors (by a qualified testing laboratory) periodically, to ensure to ensure their serviceability. Replace batteries as required.



# APPENDICES

- Make sure that everyone understands the escape plan and recognizes the sound of smoke alarm. Verify that the escape routes are clear and that doors and windows can be opened easily.
- If windows or doors in your home have security bars, make sure that the bars have quick-release mechanisms on the inside, so that they can be opened immediately in an emergency case. Quick release mechanisms won't compromise your security, but they will increase your chances of safely escaping a home fire.
- Practice the escape plan at least twice a year, making sure that everybody is involved - from kids to grandparents. Allow children to master fire escape planning and practice before holding a fire drill at night when they are sleeping. The objective is to practice, not to frighten, so telling children there will be a drill before they go to bed can be as effective as a surprise drill. If children or others do not readily waken to the sound of the smoke alarm, or if there are infants or family members with mobility limitations, make sure that someone is assigned to assist them in fire drill and in the event of an emergency.
- Agree on an outside meeting place where everyone can meet after they've escaped. Remember to get out first, and then call for help. Never go back inside until the fire department gives the OK.
- Have everyone memorize the emergency phone number of the fire department. That way any member of the household can call from a cellular phone or a neighbor's home.
- Be fully prepared for a real fire: when a smoke alarm sounds, get out immediately and once you are out, stay out - leave the firefighting to the professional!
- If you live in an apartment building, make sure that you are familiar with the building evacuation plan. In case of a fire, use the stairs, never the elevator.

Tell guests or visitors to your home about your family's fire escape plan. When visiting other people's home, ask about their escape plan. If they don't have a plan in place, offer to help them make one. This is especially important when children are permitted to attend "sleepovers" at friends' homes.

## FCC STATEMENT

The 315 MHz model of this sensor complies with Part 15 of the FCC Rules. Operation is subject to the following two conditions: (1) This sensor may not cause harmful interference, and (2) this sensor must accept any interference that may be received, including interference that may cause undesired operation.

The digital circuit of this sensor has been tested and found to comply with the limits for a Class B digital sensor, pursuant to Part 15 of the FCC Rules. These limits are designed to provide reasonable protection against harmful interference in residential installations. This equipment generates, uses and can radiate radio frequency energy and, if not installed and used in accordance with the instructions, may cause harmful interference to radio and television reception. However, there is no guarantee that interference will not occur in a particular installation. If this sensor does cause such interference, which can be verified by turning the sensor off and on, the user is encouraged to eliminate the interference by one or more of the following measures:

- Re-orient or re-locate the receiving antenna.
- Increase the distance between the sensor and the receiver.
- Connect the sensor to an outlet on a circuit different from the one which supplies power to the receiver.
- Consult the dealer or an experienced radio/TV technician.

At 315 MHz the product complies with FCC requirements.



### W.E.E.E. Product Recycling Declaration

For information regarding the recycling of this product you must contact the company from which you originally purchased it. If you are discarding this product and not returning it for repair then you must ensure that it is returned as identified by your supplier. This product is not to be thrown away with everyday waste.

Directive 2002/96/EC Waste Electrical and Electronic Equipment.



VISONIC LTD. (ISRAEL):

P.O.B 22020 TEL-AVIV 61220 ISRAEL. PHONE: (972-3) 645-6789, FAX: (972-3) 645-6788

VISONIC INC. (U.S.A.):

65 WEST DUDLEY TOWN ROAD, BLOOMFIELD CT. 06002-1376. PHONE: (860) 243-0833, (800) 223-0020

FAX: (860) 242-8094

VISONIC LTD. (UK):

7 COPPERHOUSE COURT, CALDECOTTE, MILTON KEYNES. MK7 8NL.

INTERNET:

www.visonic.com

©VISONIC LTD. 2009

POWERMAX PRO USER GUIDE DE5468U (REV. 4, 1/09)



Fully Supervised

Wireless Alarm

Control System



**Visonic**<sup>®</sup>

*For a secure way of life*